

Krantz

Variable twist outlet with

- guide ring DD-VL....
- jet straightener DD-VG....

Air distribution systems

Krantz

Variable twist outlet

with guide ring or jet straightener

Preliminary remarks

The variable twist outlet with guide ring generates turbulent mixing ventilation and is used for air supply where there is no significant pollutant load. It is very well suited for high rooms or halls where it is placed above the occupied zone.

The variable twist outlet with guide ring designed for duct connection has excellent acoustic properties. It can therefore be used in rooms calling for low sound pressure levels such as broadcasting studios, theatres and concert halls. If fitted with a jet straightener, this outlet can achieve large vertical penetration depths in heating mode, at high temperature differences between supply air and indoor air. For this reason it is also eminently suitable for use in high halls such as exhibition halls and painting hangars.

Construction design and function

The air outlet mainly consists of the outer cylinder **1**, the core tube **2**, the rounded exit **3** and the individual twist vanes **4**. The twist vanes are fixed to the outer cylinder and the core tube. The rounded exit is fitted with a coaxially mobile guide ring **5** whose height can be adjusted by a lift from 0 mm to 80 resp. 120 mm, depending on the outlet size. So the discharge direction of the air jets can be adjusted from horizontal (when cooling) to vertical down (when heating), manually or with an electric actuator **6**.

The variable twist outlet with guide ring is used for discharge heights of 3 to 12 m. A jet straightener **7** is inserted in the guide ring for discharge heights of up to 28 m.

The air outlet can be connected to the duct system either directly using a circular duct to EN 1506 or via a connection box. It may also be connected to the bottom of a rectangular duct via a spigot to be provided by the client (for details see [page 3](#)).

Size		DN 315	DN 400	DN 500	DN 630	DN 710
Volume flow rate	l/s	170 – 550	280 – 970	420 – 1 530	830 – 2 500	1 100 – 3 055
	m ³ /h	600 – 2 000	1 000 – 3 500	1 500 – 5 500	3 000 – 9 000	4 000 – 11 000
Discharge height with	– guide ring	3 – 9	4 – 10	4 – 10	5 – 11	6 – 12
	– jet straightener	3 – 15	4 – 20	4 – 22	5 – 25	6 – 28
Max. temperature difference $\Delta\theta_{\max}$ between supply air and return air		–10 K when cooling +15 K when heating, with guide ring +20 K when heating, with jet straightener				



Variable twist outlet
Top: with guide ring; bottom: with jet straightener

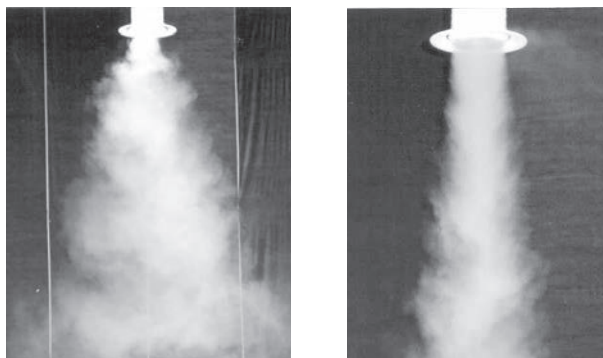

Jet dispersion made visible with smoke tracer
Top: cooling mode - The cool supply air is discharged horizontally and flows downwards slowly and evenly
Bottom: heating mode - The warm vertical supply air jets penetrate deep into the occupied zone,
left: with guide ring, right: with jet straightener

Variable twist outlet

with guide ring or jet straightener – Dimensions

Connection to circular duct

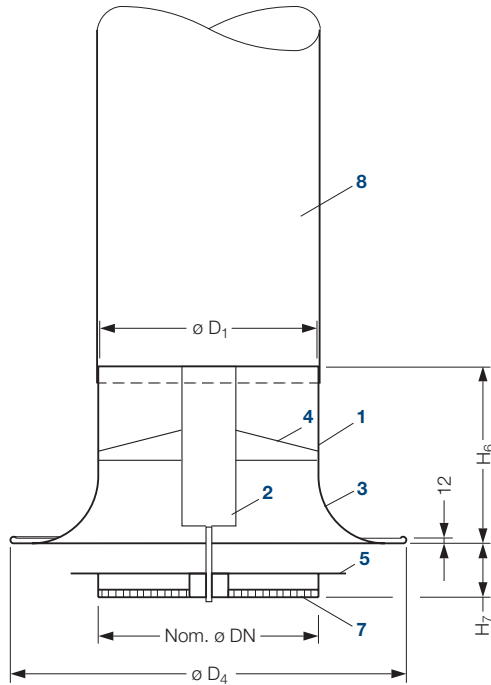

Connection to rectangular duct with spigot

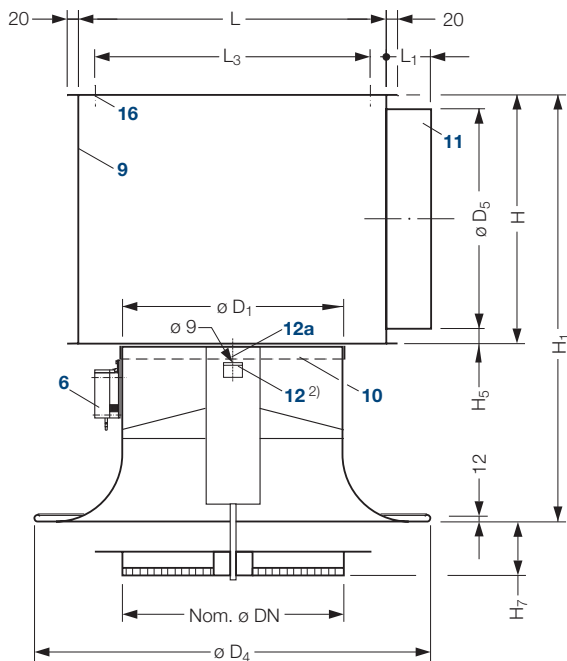
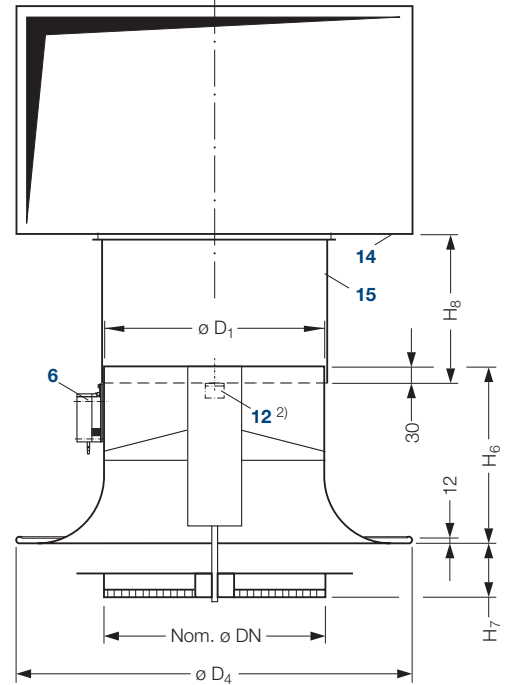

Connection to connection box

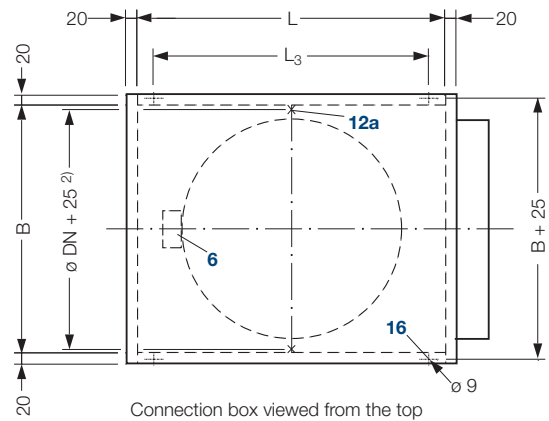

Key

- 1 Outer cylinder
- 2 Core tube
- 3 Exit
- 4 Twist vane
- 5 Guide ring
- 6 Actuator
- 7 Jet straightener
- 8 Circular duct
- 9 Connection box
- 10 Sleeve at connection box
- 11 Connection spigot
- 12 L-fastener²⁾ (on 2 sides)
- 12a Screw connection to box bottom
- 14 Rectangular duct
- 15 Spigot for duct connection
- 16 Hole for suspension

Size	Dimensions														Weight in kg ¹⁾	
	L mm	L ₁ mm	L ₃ mm	B mm	H mm	H ₁ mm	H ₅ mm	H ₆ mm	H _{7 max} mm	H _{8 min} mm	$\varnothing D_1$ mm	$\varnothing D_2^{3)}$ mm	$\varnothing D_4$ mm	$\varnothing D_5$ mm	Air outlet	With connection box
DN 315	475	60	415	365	365	690	19	320	90	500	314	500	565	314	6	16.5
DN 400	560	80	500	450	450	775	25	320	106	600	399	650	720	399	8	23.0
DN 500	660	80	560	550	555	960	25	400	100	750	499	820	900	499	11	31.0
DN 630	790	80	730	680	680	1 185	25	500	110	950	628	1 000	1 080	628	16	41.0
DN 710	872	100	790	762	761	1 375	25	600	120	1 070	709	1 200	1 278	709	20	50.0

¹⁾ Without actuator; weight of actuator 0.5 – 0.8 kg

²⁾ In case of connection to a box and mounting flush with the ceiling, the L-fastener is positioned inside ($\varnothing DN - 30$ mm)

³⁾ Ceiling cutout

Variable twist outlet

with guide ring or jet straightener – Comfort criteria

Comfort criteria ¹⁾

The outlet layout must comply with the maximum allowable indoor air velocities u in the occupied zone in cooling mode. The indoor air velocity depends on the cooling load that is to be removed from the room. The maximum specific cooling capacity \dot{q} depends on the discharge height and the maximum allowable indoor air velocity u (Graph 1).

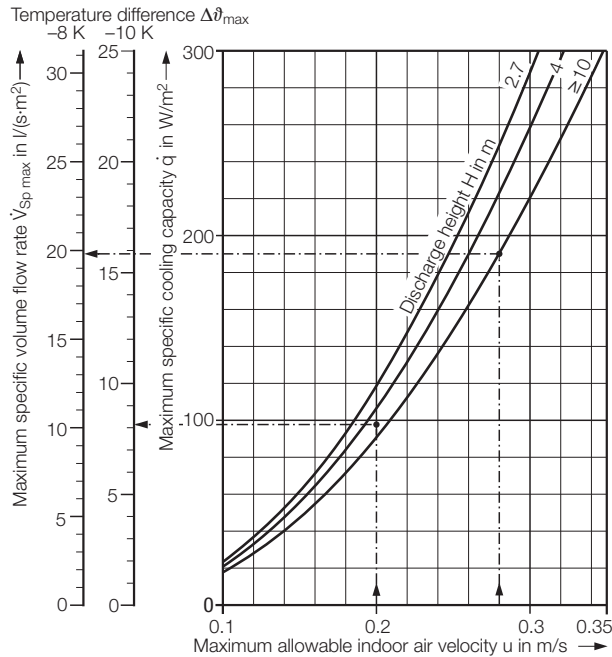

Graph 1: Maximum specific volume flow rate

Layout example		Assembly shop for electrical equipment	Aircraft assembly hangar
Outlet type, Size		Guide ring, DN 315	Jet straightener, DN 630
Connection to		Circular duct	Connection box
1 Supply air volume flow rate \dot{V}	l/s	8 890	75 000
2 Discharge height H	m	7	20
3 Floor area A	m ²	1 450	5 400
4 Max. allowable sound power level L_{WA}	dB(A) ref. 10 ⁻¹² W	65	75
5 Max. temperature difference supply air to indoor air: $\Delta\theta_{cooling}$	K	-10	-8
$\Delta\theta_{heating}$	K	7.5	5
6 Comfort criteria			
– Max. allowable return air velocity u	m/s	0.2	0.28
– Max. specific volume flow rate $\dot{V}_{Sp\ max}$	l/(s·m ²)	8	20
– Actual specific volume flow rate [from 1 : 3] $\dot{V}_{Sp\ act}$	l/(s·m ²)	6	14
Criterion is met if $\dot{V}_{Sp\ act} < \dot{V}_{Sp\ max}$			
From nomogram			
7 $\dot{V}_{A\ min\ H}$	l/s	444 [at $\Delta\theta = 7.5$ K]	2 111 [at $\Delta\theta = 5$ K]
8 \dot{V}_A selected	l/s	492	2083
9 Z [from 1 : 8]	units	18	36
10 $L_{WA\ max}$	dB(A)	54	≈ 75
11 $\Delta p_{t\ max}$	Pa	85	130
12 t_{min}	m	≈ 7.8	≈ 10.2

Graph 1 enables to determine for the cooling mode the maximum specific volume flow rate $\dot{V}_{Sp\ max}$ in relation to the maximum specific cooling capacity and the maximum temperature difference $\Delta\theta_{max}$. The volume flow rate supplied to the room $\dot{V}_{Sp\ act}$ may not exceed this value.

Graph 2 enables to determine the minimum centre spacing between two outlets on the basis of the maximum specific volume flow rate.

Key for layout:

- \dot{V}_A = volume flow rate per air outlet in l/s
- $\dot{V}_{A\ min\ H}$ = min. volume flow rate per air outlet in l/s, when heating, with $\Delta\theta = ..K$
- $\dot{V}_{Sp\ max}$ = max. specific volume flow rate per m² in l/(s·m²)
- $\dot{V}_{Sp\ act}$ = actual specific volume flow rate per m² of floor area in l/(s·m²)
- u = max. allowable indoor air velocity in m/s
- \dot{q} = max. specific cooling capacity in W/m²
- $\Delta\theta_{max}$ = max. temperature difference supply air to return air in K
- t_{min} = minimum air outlet centre spacing in m
- H = discharge height in m
- L_{WA} = sound power level in dB(A) ref. 10⁻¹² W
- Δp_t = total pressure drop in Pa
- Z = Number of air outlets
- RV = duct connection, vertical discharge
- RH = duct connection, horizontal discharge
- KV = connection box, vertical discharge
- KH = connection box, horizontal discharge

¹⁾ See our brochure ref. TB 69 'Layout specifications for thermal comfort'

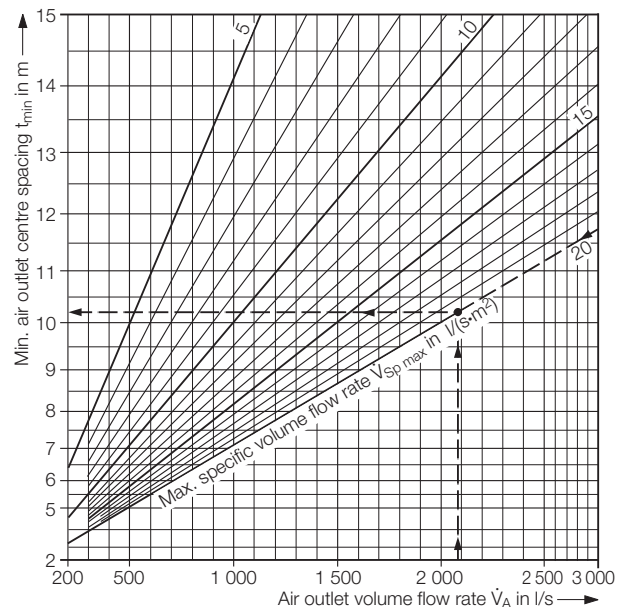
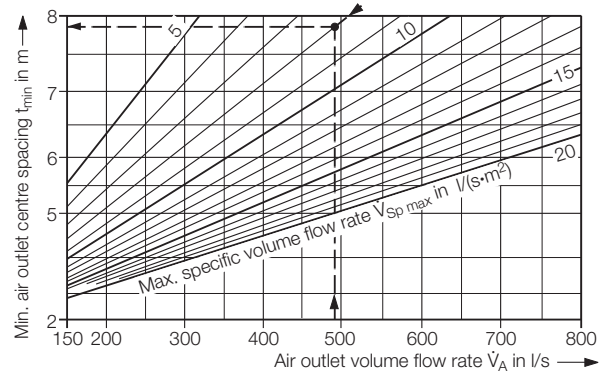

Graph 2: Minimum air outlet centre spacing

Variable twist outlet DD-VL

with guide ring – Layout sheet DN 315 to DN 500

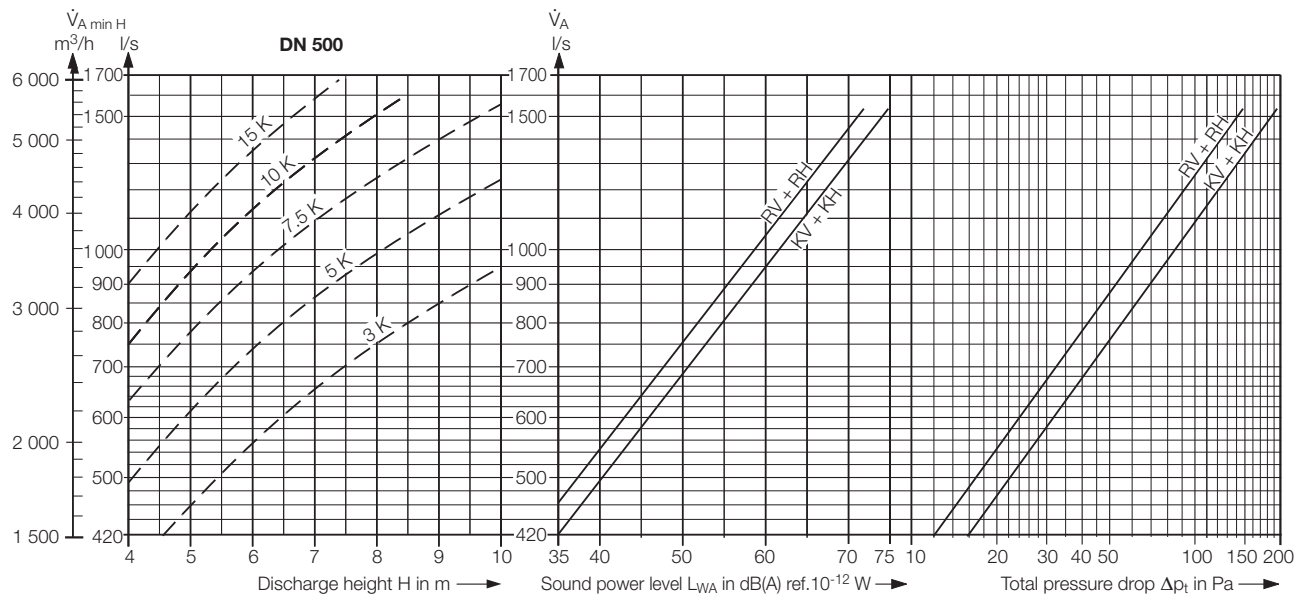
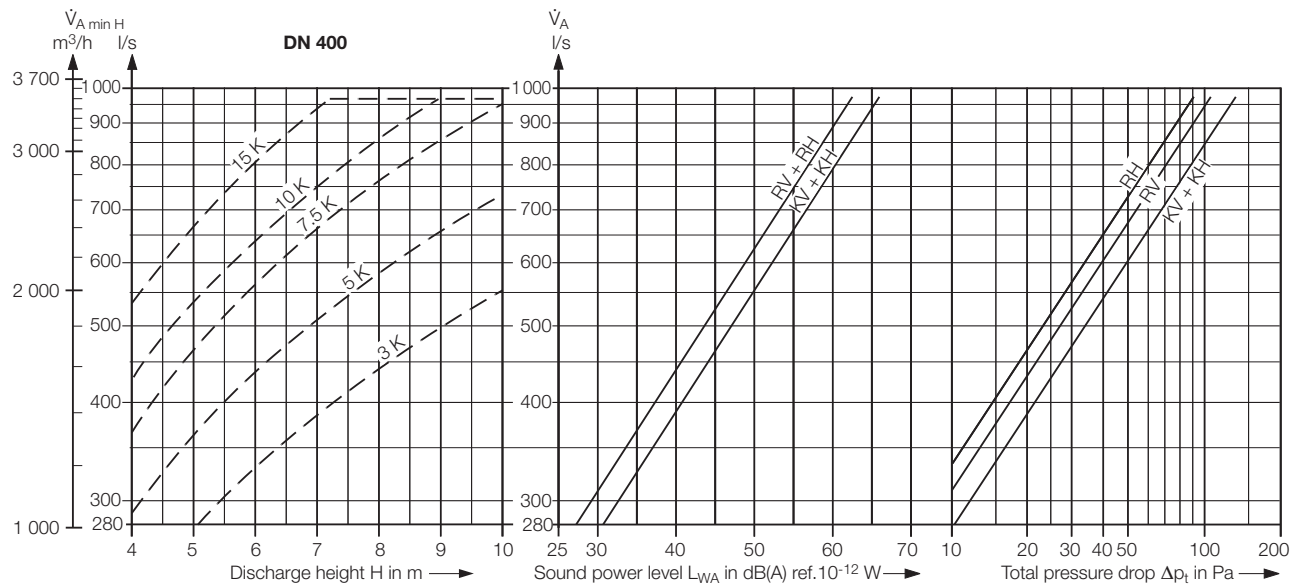
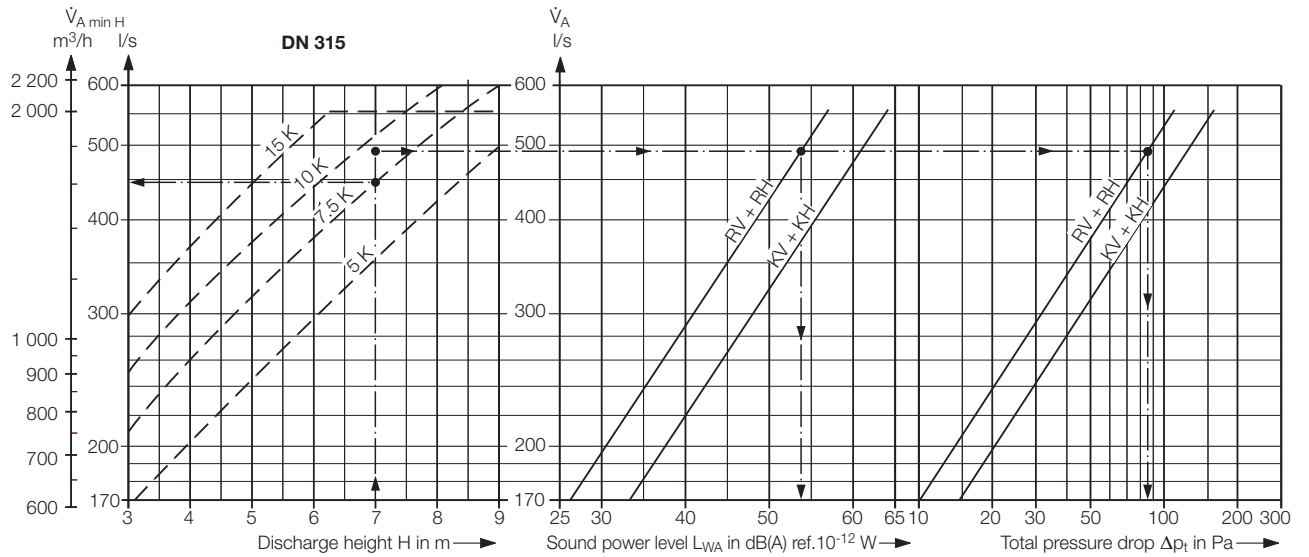

Variable twist outlet DD-VL

with guide ring – Layout sheet DN 630 to DN 710

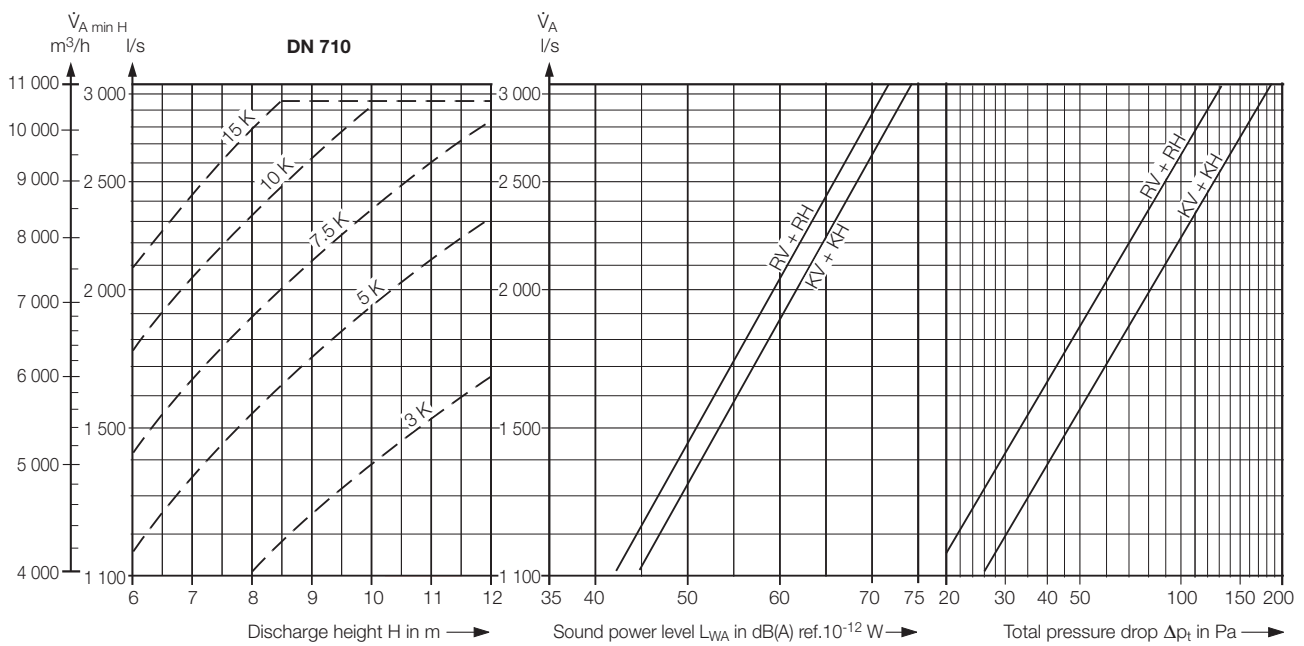
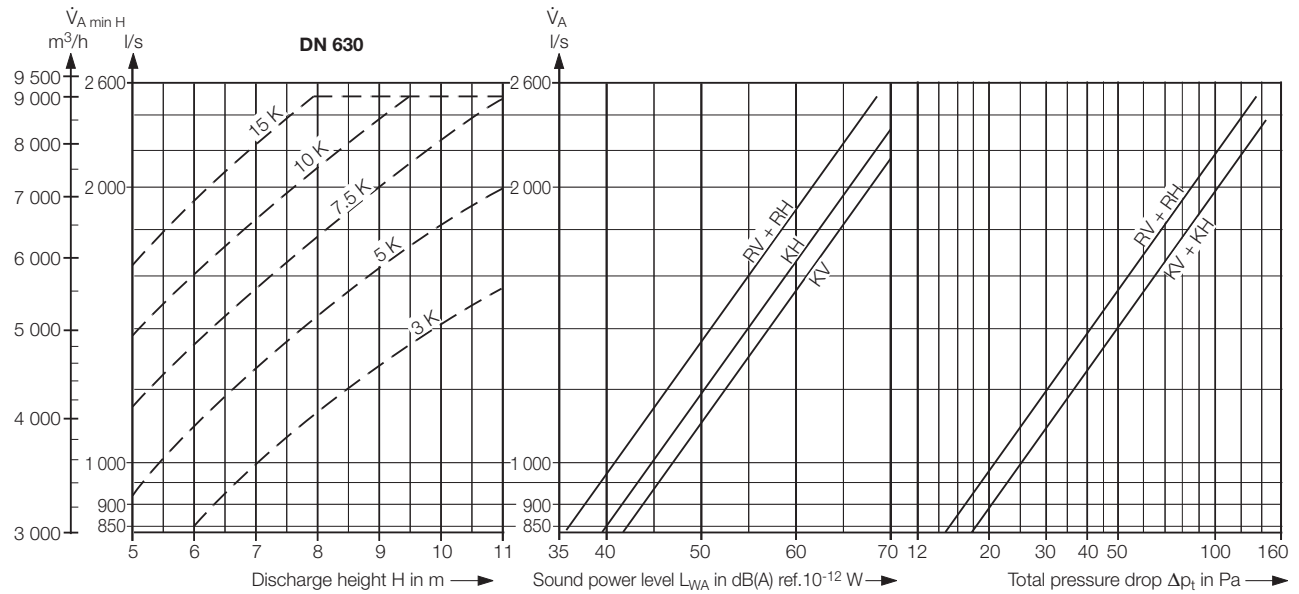

Variable twist outlet DD-VL

with guide ring – Layout sheet

Air outlet volume flow rate		Duct connection	Total pressure drop Δp_t Pa	Sound power level L_W in dB ref. $10^{-12}W$										Connection box	Total pressure drop Δp_t Pa	Sound power level L_W in dB ref. $10^{-12}W$									
\dot{V}_A				L_{WA} dB(A)	Octave band centre frequency in Hz								L_{WA} dB(A)			Octave band centre frequency in Hz									
l/s	m ³ /h				63	125	250	500	1 K	2 K	4 K	8 K				63	125	250	500	1 K	2 K	4 K	8 K		
Variable twist outlet with guide ring																									
DN 315																									
280	1 000	RH	27	39	54	44	37	35	33	32	24	14	KH	40	46	58	49	40	43	42	37	28	18		
		RV	27	39	35	37	41	36	32	30	24	15	KV	40	46	59	48	42	43	42	37	29	19		
415	1 500	RH	60	50	65	55	49	46	43	42	35	23	KH	90	57	69	60	53	54	52	48	43	31		
		RV	60	50	46	48	52	48	43	41	36	28	KV	90	57	67	56	54	56	50	47	43	34		
555	2 000	RH	115	57	72	62	57	54	50	49	43	30	KH	160	64	76	67	60	61	60	55	50	38		
		RV	115	57	53	55	60	56	50	48	44	38	KV	160	64	74	63	61	63	58	54	50	41		
DN 400																									
415	1 500	RH	17	38	43	37	32	38	36	22	<10	<10	KH	24	42	50	41	41	40	38	30	14	<10		
		RV	19	38	42	44	37	40	35	22	<10	<10	KV	24	42	53	42	42	42	36	27	16	<10		
555	2 000	RH	30	46	53	47	41	46	44	34	20	<10	KH	42	50	57	48	48	49	46	39	26	<15		
		RV	34	46	52	50	46	47	43	34	23	<10	KV	42	50	60	49	50	50	45	38	28	<15		
835	3 000	RH	67	58	67	61	54	58	55	50	40	26	KH	95	62	69	60	59	62	58	53	43	31		
		RV	77	58	63	58	57	58	53	51	43	31	KV	95	62	70	59	62	57	52	45	45	33		
DN 500																									
695	2 500	RH	32	48	55	47	41	42	43	38	38	17	KH	42	51	56	52	48	47	45	42	39	28		
		RV	32	48	48	47	44	43	43	40	32	19	KV	42	51	53	48	49	48	45	43	39	31		
1 110	4 000	RH	81	62	70	63	58	53	54	55	54	39	KH	107	65	69	65	62	61	59	56	53	42		
		RV	81	62	56	57	58	54	55	55	52	41	KV	107	65	67	61	63	61	59	57	53	45		
1 530	5 500	RH	153	71	80	73	69	60	61	67	69	56	KH	202	74	78	74	71	70	68	65	62	51		
		RV	153	71	62	63	67	63	63	66	69	60	KV	202	74	76	71	72	71	69	66	62	54		
DN 630																									
1 400	5 000	RH	41	51	62	52	49	46	45	41	37	25	KH	50	55	65	56	54	52	50	46	42	32		
		RV	41	51	48	50	52	46	46	41	39	31	KV	50	57	64	53	58	53	51	48	42	34		
1 800	6 500	RH	70	59	70	60	57	54	53	49	45	33	KH	84	63	73	64	62	60	58	54	50	40		
		RV	70	59	56	58	60	54	53	49	47	38	KV	84	65	72	61	65	61	59	56	50	42		
2 220	8 000	RH	106	65	76	66	64	60	59	55	51	39	KH	126	69	80	70	68	66	64	60	56	46		
		RV	106	65	62	64	60	60	60	56	53	45	KV	126	71	78	67	72	67	65	62	56	48		
DN 710																									
1 400	5 000	RH	28	48	52	48	45	41	44	39	31	26	KH	40	51	50	50	51	46	47	39	49	11		
		RV	28	48	38	48	46	40	44	38	29	10	KV	40	51	54	51	50	46	46	39	30	23		
2 220	8 000	RH	72	62	65	61	57	53	55	58	56	44	KH	102	65	63	61	64	59	58	58	59	43		
		RV	72	62	48	55	61	53	55	55	57	34	KV	102	65	67	64	63	59	57	58	62	40		
3 055	11 000	RH	136	71	74	69	64	60	63	70	72	55	KH	193	74	71	67	72	66	66	70	82	63		
		RV	136	71	54	61	70	61	63	66	85	51	KV	193	74	76	73	71	67	65	71	87	51		

Variable twist outlet DD-VG

with jet straightener – Layout sheet DN 315 to DN 500

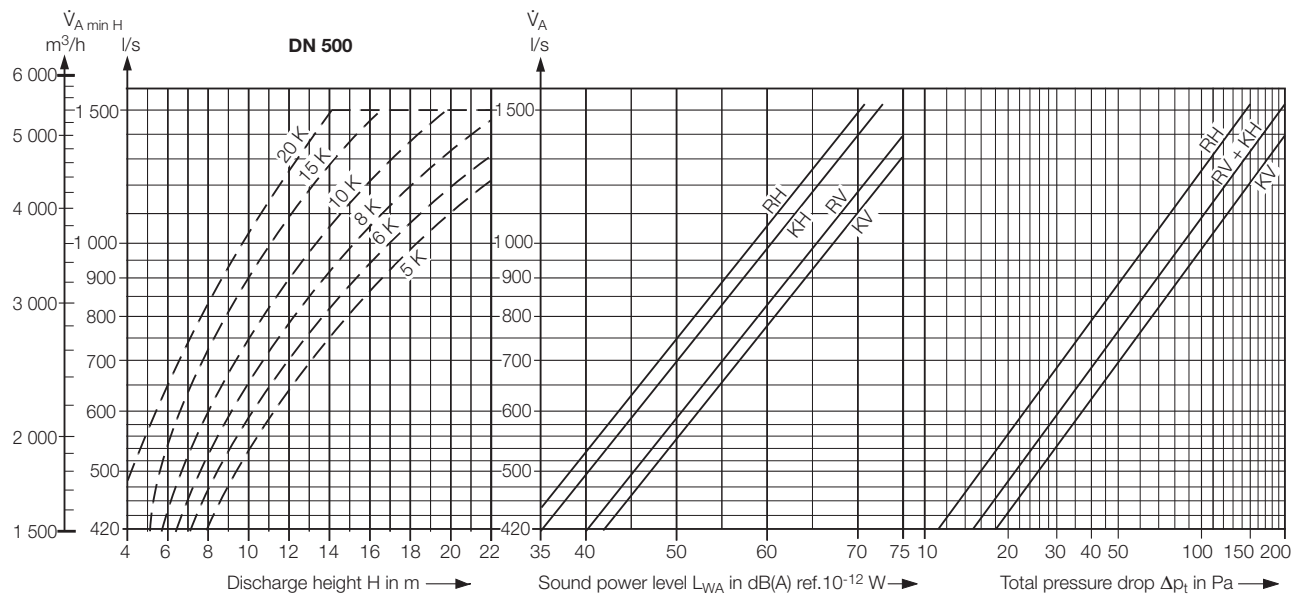
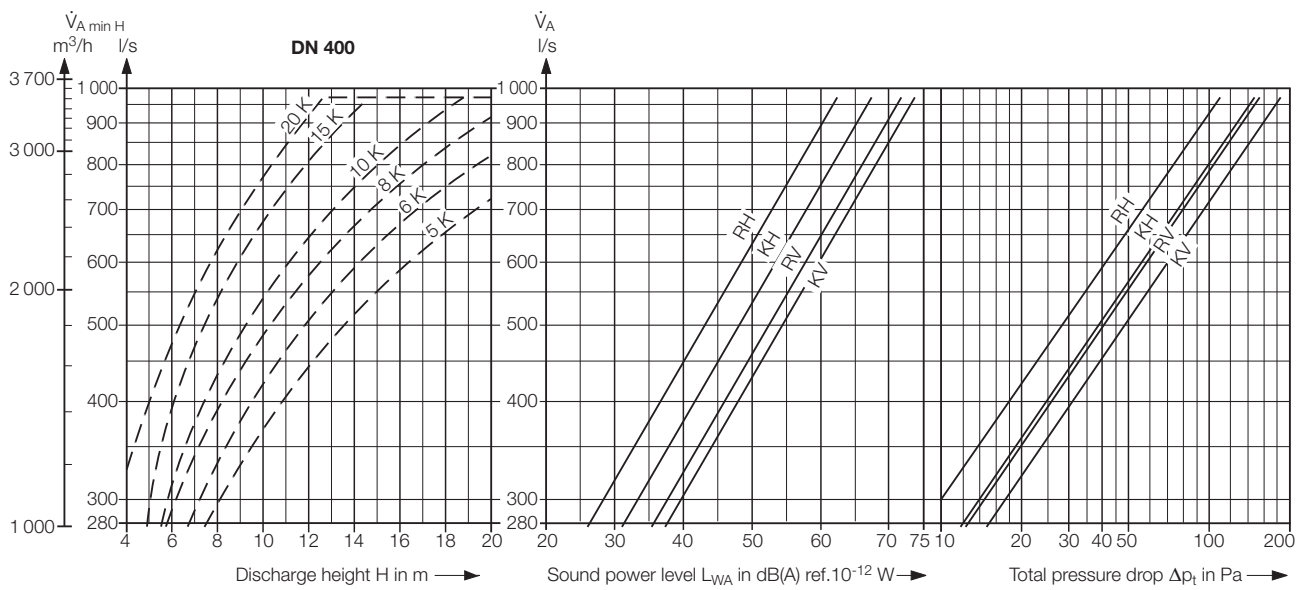
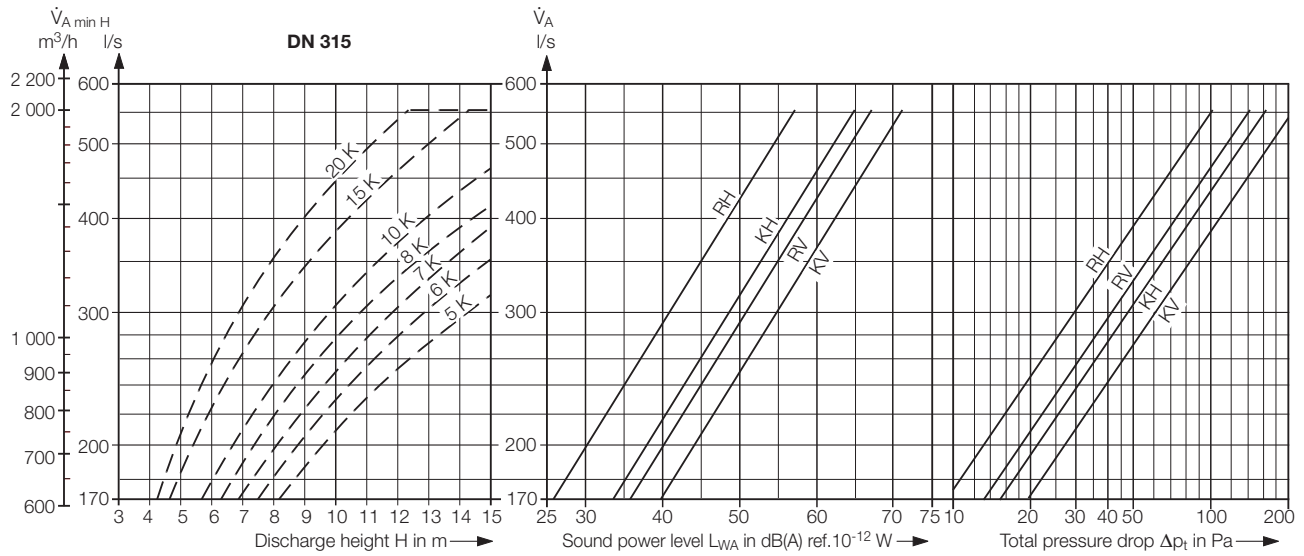

Variable twist outlet DD-VG

with jet straightener – Layout sheet DN 630 to DN 710

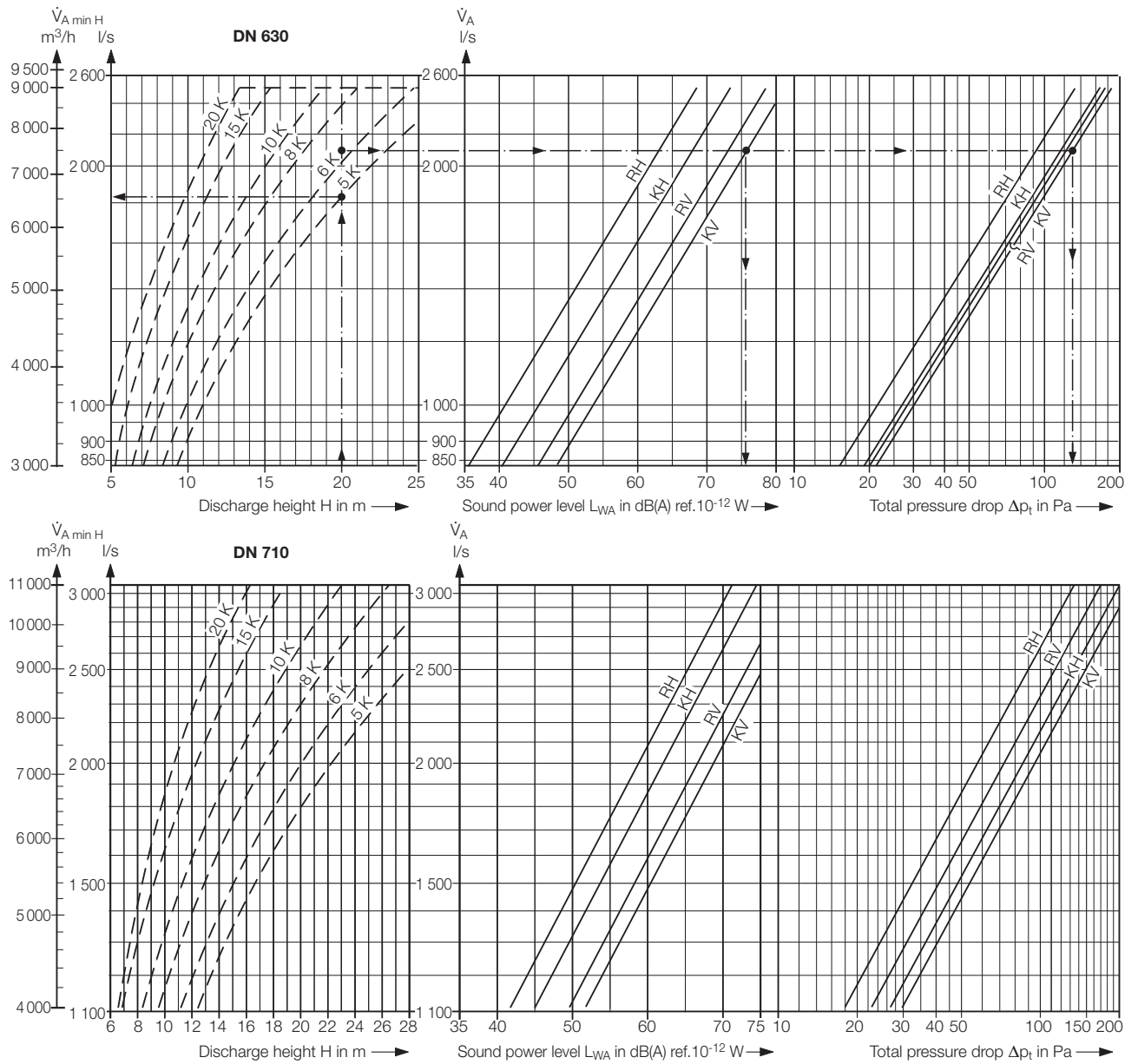

Variable twist outlet DD-VG

with guide ring or jet straightener – Sound power level and pressure drop

Air outlet volume flow rate		Duct connection	Total pressure drop Δp_t Pa	Sound power level L_W in dB ref. $10^{-12}W$										Connection box	Total pressure drop Δp_t Pa	Sound power level L_W in dB ref. $10^{-12}W$									
\dot{V}_A				L_{WA} dB(A)	Octave band centre frequency in Hz								L_{WA} dB(A)			Octave band centre frequency in Hz									
l/s	m ³ /h				63	125	250	500	1 K	2 K	4 K	8 K				63	125	250	500	1 K	2 K	4 K	8 K		
Variable twist outlet with jet straightener																									
DN 315																									
280	1 000	RH	25	39	54	44	38	36	33	32	24	16	KH	40	47	59	50	41	44	43	39	29	16		
		RV	35	49	42	43	45	45	44	42	42	32	KV	50	53	56	49	46	49	49	45	43	35		
415	1 500	RH	56	50	65	55	49	47	43	43	35	27	KH	90	57	70	61	53	55	53	49	44	34		
		RV	78	59	48	49	52	53	53	51	51	47	KV	118	63	64	57	56	59	58	55	54	51		
555	2 000	RH	100	57	72	62	57	54	50	50	43	35	KH	160	65	77	68	60	62	61	56	51	41		
		RV	139	67	56	57	60	61	61	59	59	55	KV	208	71	72	65	64	67	66	63	62	59		
DN 400																									
415	1 500	RH	20	38	49	37	33	37	34	25	<10	<10	KH	26	43	53	44	39	42	40	33	22	<15		
		RV	28	47	42	44	45	45	42	37	30	14	KV	34	49	54	47	45	48	43	41	35	25		
555	2 000	RH	35	46	55	47	43	45	42	36	23	11	KH	47	52	61	52	47	51	48	41	30	18		
		RV	50	55	49	50	53	53	51	47	43	30	KV	60	57	62	55	52	54	52	51	48	40		
835	3 000	RH	79	58	70	60	56	57	53	51	42	32	KH	104	63	73	64	57	63	58	54	47	39		
		RV	112	67	61	60	64	64	63	62	62	51	KV	135	69	72	65	63	66	63	62	59	54		
DN 500																									
695	2 500	RH	32	48	56	48	43	40	41	40	39	25	KH	40	50	55	50	47	48	45	41	30	19		
		RV	40	54	46	47	50	49	50	47	44	37	KV	50	57	55	53	54	54	53	49	43	31		
1 110	4 000	RH	81	62	70	62	57	54	55	54	53	39	KH	103	64	68	65	61	60	58	56	54	41		
		RV	103	68	60	61	64	63	64	61	58	51	KV	127	71	65	65	68	66	66	63	61	54		
1 530	5 500	RH	154	71	80	71	67	64	65	63	62	49	KH	195	73	76	75	71	68	66	67	70	57		
		RV	195	78	69	71	74	73	73	71	67	61	KV	238	80	73	72	77	75	75	73	74	69		
DN 630																									
1 400	5 000	RH	41	51	62	52	50	47	45	41	37	25	KH	51	56	65	56	54	52	50	47	42	34		
		RV	55	61	54	55	58	56	56	53	48	43	KV	60	63	66	59	62	59	59	56	51	46		
1 800	6 500	RH	69	59	70	60	58	55	53	49	45	33	KH	86	63	73	64	62	60	58	55	50	42		
		RV	93	68	62	63	66	63	63	61	56	51	KV	102	71	74	67	70	67	66	63	59	54		
2 220	8 000	RH	104	65	76	66	64	61	59	55	51	39	KH	130	70	79	70	68	66	64	61	56	48		
		RV	140	75	68	69	73	70	70	67	62	57	KV	154	78	80	74	76	73	73	70	65	60		
DN 710																									
1 400	5 000	RH	28	48	52	49	46	42	43	38	28	28	KH	42	52	54	52	51	47	47	42	35	23		
		RV	35	56	49	52	53	51	51	49	43	27	KV	48	58	53	55	56	55	54	51	45	30		
2 220	8 000	RH	72	62	68	61	58	53	55	57	56	38	KH	108	65	68	65	63	59	58	58	59	40		
		RV	90	70	59	63	67	63	64	63	64	56	KV	123	72	66	67	69	67	67	66	66	57		
3 055	11 000	RH	136	71	77	69	65	60	63	70	76	45	KH	204	74	78	74	72	68	66	70	76	52		
		RV	171	80	66	70	77	71	73	73	78	77	KV	232	82	76	74	79	75	76	76	80	75		

Variable twist outlet

Type code, Features and tender text

Type code

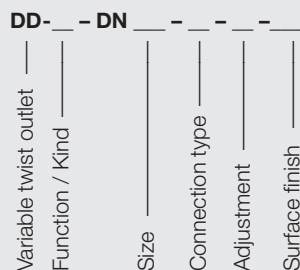

Function / Kind

- VL = variable with guide ring
- VG = variable with jet straightener

Size

DN 315, DN 400, DN 500, DN 630, DN 710

Connection type

- R = duct connection with rivets or screws
- K = connection box ¹⁾

Adjustment

	DN 315 + DN 400	DN 500 – DN 710
MA = manual	•	•
E7 = „Belimo actuator, 0 – 10 V modulation“, rotation drive type NM24A-SR	•	
E8 = „Belimo actuator, 3-point drive, 24 V“, rotation drive type NM24A	•	
E9 = „Belimo actuator, 3-point drive, 230 V“, rotation drive type NM230A	•	
E10 = „Belimo actuator, 0 – 10 V modulation“, rotation drive type SM24A-SR		•
E11 = „Belimo actuator, 3-point type, 24 V“, rotation drive type SM24A		•
E12 = „Belimo actuator, 3-point type, 230 V“, rotation drive type SM230A		•
E13 = „Siemens actuator, 0 – 10 V modulation“, rotation drive type GLB161.1E	•	
E14 = „Siemens actuator, 3-point type, 24 V“, rotation drive type GLB131.1E	•	
E15 = „Siemens actuator, 3-point type, 230 V“, rotation drive type GLB331.1E	•	
E19 = „Siemens actuator 0 – 10 V modulation“, rotation drive type GEB161.1E		•
E20 = „Siemens actuator, 3-point type, 24 V“, rotation drive type GEB131.1E		•
E21 = „Siemens actuator, 3-point type, 230 V“, rotation drive type GEB331.1E		•

Surface finish

.... = face painted to RAL

Features

- Turbulent mixing ventilation
- Volume flow rate range from 170 to 3 055 l/s [600 to 11 000 m³/h]
- Jet penetration depth adaptable to room height and thermal load
- Even temperature and humidity distribution throughout the room
- Discharge direction adjustable from horizontal to vertical down
- Adjustment manually or with electric actuator
- Discharge height for outlet with guide ring: 3 to 12 m, for outlet with jet straightener: best from 3 to 28 m
- Maximum temperature difference supply air to return air:
 - 10 K when cooling and
 - +15 K when heating, with guide ring
 - +20 K when heating, with jet straightener
- Sizes DN 315, DN 400, DN 500, DN 630 and DN 710
- Low weight as the main components are made of aluminium
- The air outlet is powder coated to a RAL colour
- Different connection types
- Accelerated heating-up
- For commercial and industrial applications

Tender text

..... units

Variable twist outlet for air supply from great discharge heights, with high-induction radial air jets and discharge direction adjustable from horizontal to vertical down, suitable for cooling and heating with great temperature differences between supply air and return air,

consisting of:

outer cylinder with straight intake for connection to a circular duct, core tube, rounded exit, and twist vanes fixed between outer cylinder and core tube; with adjustable guide ring for discharge heights of 3 to 12 m and also with jet straightener for great discharge heights of 3 to 28 m; adjustment either manually or with electric actuator.

Connection to the duct system either directly to a circular duct to EN 1506, with L-fasteners, or via a connection box with connection spigot.

Material:

- Air outlet made of aluminium powder coated to RAL
- Connection box made of galvanized sheet metal

Make:

Krantz

Type:

DD-__ - DN __ - - - -

Subject to technical alteration.

¹⁾ L-fastener

- outside with ceiling-flush installation,
- inside with freely suspended installation

Krantz GmbH

Uersfeld 24, 52072 Aachen, Germany

Phone: +49 241 441-1

Fax: +49 241 441-555

info@krantz.de | www.krantz.de

The logo for Krantz GmbH, featuring the word "Krantz" in a stylized, blue, cursive script font.