

Static cooling ceiling system SKS-5/3
for visible installation

Static cooling ceiling system SKS-5/3

for visible installation

Main features	2
Preliminary remarks / Applications	3
Main dimensions and materials	3
Construction design	4
Design data	5
Design specifications (cooling mode)	6
Layout fundamentals (cooling mode)	8
Mounting instructions	9
Operation and maintenance	10
Tender text	10

Main features

- Cooling and heating ceiling elements available in various lengths and widths, active area up to 4 m²
- High specific cooling output with heat removal largely by radiation:
Standard cooling output 160 W/m² of element if designed as cooling sail (to DIN 4715)
- Robust and stable element construction
- Low element height: 60 mm
- Attractive linear-panel appearance; various arrangement and design options available

- Most suitable for use in
 - office spaces
 - spaces requiring increased cooling outputs up to 120 W/m² under comfort conditions, e.g. meeting rooms, exhibition spaces
- Operation possible with higher water temperatures in order to
 - prevent condensation
 - utilize an energy-efficient system for chilled water production
- Good dynamic response when cooling or heating thanks to free heat exchange with the environment
- The system utilizes the storage capacity of the concrete slab
- Only slight temperature differences in the occupied zone

- Combinable with any air distribution system
- Sound-absorbing material can be fitted behind the cooling/heating ceiling elements to get a ceiling with good acoustic properties
- Suitable for both cooling and heating
- Easy to install applying methods in use in building services and drywall construction
- Ideally suited for retrofitting or addition to existing suspended ceiling systems
- All-metal assembly, thus non-flammable

Static cooling ceiling system SKS-5/3

for visible installation

Preliminary remarks / Applications

The SKS system is the proven high-capacity static cooling & heating ceiling system from KRANTZ KOMPONENTEN. It provides optimum solutions for a wide range of applications, mainly in the commercial sector, but it is also suitable for spaces with high heat loads such as meeting rooms, industrial spaces, and TV studios.

Cooling & heating elements of the SKS system family are available in various options:

- for concealed installation above a suspended ceiling
- for visible installation – in place of or built into a suspended ceiling
- for meeting specific acoustic requirements
- for fulfilling special fire protection criteria.

A proven option refers to visible installation. It is especially for such applications that type SKS-5/3 has been developed. As this system has an attractive linear-panel appearance, it fulfils high requirements for ceiling aesthetics while providing optimum cooling and heating outputs. Two basic arrangement options are available:

- cooling/heating **sails** which are freely suspended from the concrete ceiling, with no surrounding suspended ceiling,
- cooling/heating **islands** which are incorporated into a suspended or linear grid ceiling.

(See both options in Figs. 9 and 10 on page 7).

This system affords various adaptable layout options, which leaves great scope for the ceiling design and for accommodating ceiling services.

The following features make SKS-5/3 a popular cooling & heating ceiling system for visible installation:

- outstanding inherent stability of the elements
- optimized fastening system
- possibility of combining these elements with ceiling services (e.g. lighting fixtures, air diffusers, sprinkler heads, loud-speakers).

SKS-5/3 is suitable for new-build and refurbishment projects as well as for completing existing HVAC systems.

Main dimensions and materials

	Standard
Nominal length (L):	1,000 mm ≤ L ≤ 4,000 mm, in 100 mm steps
Nominal width (B):	430 mm ≤ B ≤ 1,480 mm, in 150 mm steps
Nominal height:	60 mm
Recommended maximum area (LxB):	4 m ²
Recommended mounting height (for no drop in output):	≥ 185 mm, i.e. min. 125 mm from element top to ceiling
Serpentine piping:	very pure copper tube (Cu-DHP = phosphorus deoxidised copper) 12 mm x 0.5 mm, 100% subjected to eddy current testing, to DIN 12449
Pipe spacing (T):	150 mm
Cooling fins:	aluminium extruded profile
Fastening and L-shaped profiles:	galvanized sheet metal
Surface finish:	powder coating or wet painting to RAL colour of choice (standard: RAL 9010, pure white)
Pipe connections:	push-in fitting, OD 12 mm, e.g. for connection to flexible hoses, or press fitting, OD 12 mm
Allowable operating pressure:	6 bars (higher values subject to enquiry)
Weight:	approx. 9 – 11 kg/m ² when filled with water

Static cooling ceiling system SKS-5/3

for visible installation

Construction design

SKS cooling & heating elements are very stable elements whose length and width can be easily adapted to the room layout. An element is made up of:

- continuous copper serpentine tube with connections for water inflow and outflow,
- fins made from aluminium profile onto which the copper tube is pressed in a way to ensure an effective and durable heat conduction,
- Z-shaped fastening profiles made from galvanized sheet metal, positioned on the fins' upper sides, allowing direct suspension of the SKS element from the concrete ceiling.

Each element is carefully powder coated or wet painted to a standard RAL colour or a colour specified by the client.

Depending on the application and their nominal dimensions, the elements can be optionally fitted with:

- fins milled off on the rear in order to get sides looking like thin lines
- endwise L-shaped cover profiles
- additional Z-shaped fastening profiles, positioned on the fins' upper sides, for element lengths > 3.0 m
- cutouts or inactive fin sections for incorporating lighting fixtures or other ceiling services.

The dimensions to know for selecting SKS-5/3 elements are shown in Fig. 1 and further details are given on page 3 under 'Main dimensions and materials'.

As indicated in Fig. 1 the width (B) of an SKS-5/3 element will be calculated by the following equation:

$$B = (N \cdot T) - 20 \text{ mm}$$

where

N is the number of fins;

T is the pipe spacing.

The number of fins determines the width of an element and the position of the water connections. If the number of fins is even, you have the water connections on one side; if it is odd, you have the water connections on alternate sides.

For reasons relating to handling and transport we recommend to limit the surface area of single elements to 4 m². To get larger cooling & heating ceiling systems you just have to combine several SKS-5/3 elements together.

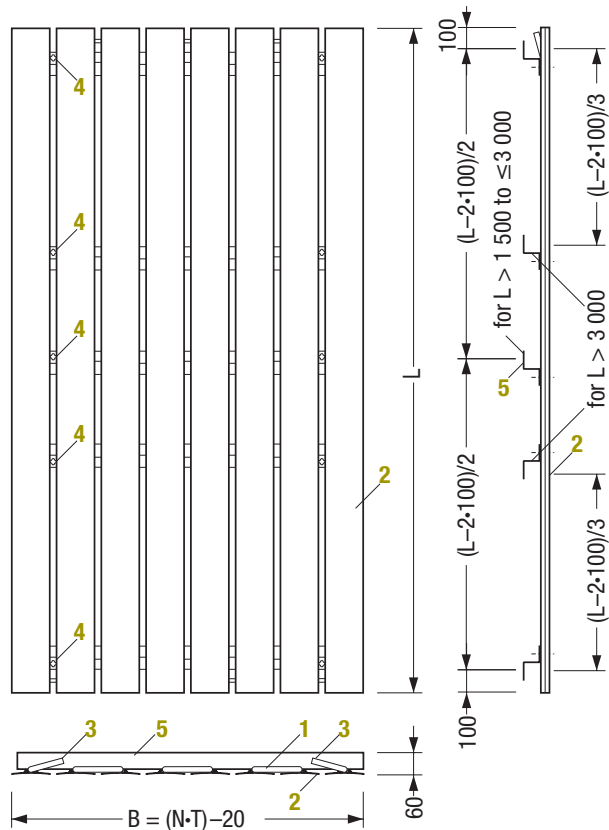

- Key**
- 1 Copper serpentine tube \varnothing 12 mm
 - 2 Cooling fin
 - 3 Water connection
 - 4 Mounting holes
 - 5 Z-shaped fastening profile
 - 6 L-shaped cover profile (option)
- 2 pieces if $L \leq 1,500$ mm
 3 pieces if $1,500 < L \leq 3,000$ mm
 4 pieces if $3,000 < L \leq 4,000$ mm

Element width and position of water connections		
Number of fins (N)	Water connections on	Actual width (B) mm
3	alternate sides	430
4	one side	580
5	alternate sides	730
6	one side	880
7	alternate sides	1,030
8	one side	1,180
9	alternate sides	1,330
10	one side	1,480

Fig. 1: SKS-5/3 element, main dimensions

Customized solutions can be worked out on enquiry to take account of a particular ceiling design, a different fin geometry or pipe spacing, etc.

Static cooling ceiling system SKS-5/3

for visible installation

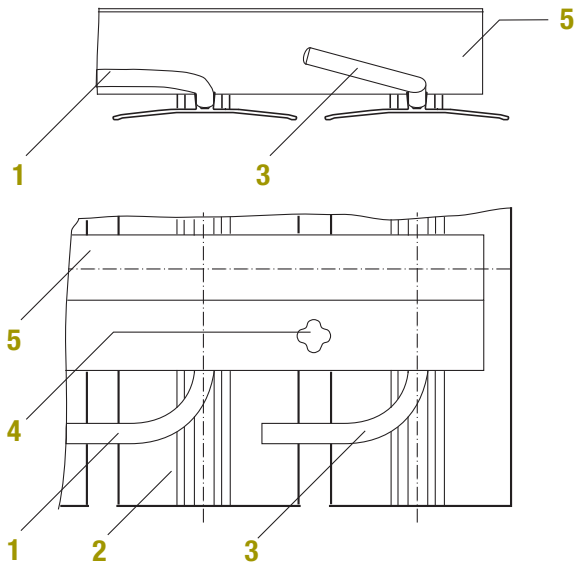

Fig. 2: Fins in standard condition (not milled off)

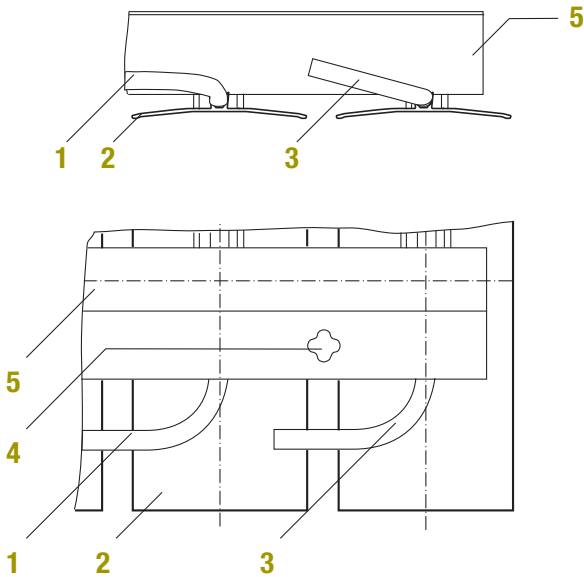

Fig. 3: Fins milled off on the rear

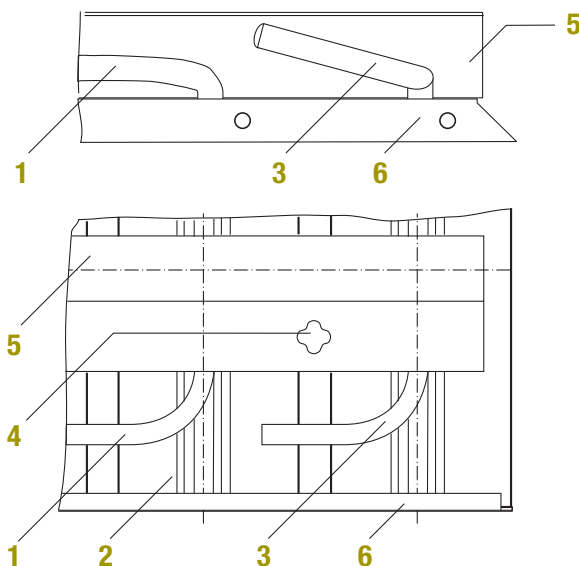

Fig. 4: Fins with L-shaped cover profile

Design data

The cooling output of SKS-5/3 elements has been determined for various arrangements in accordance with DIN 4715-1. If these elements are arranged as freely suspended cooling sails, the standard cooling output amounts to 160 W/m² of cooling element (projected surface area). Fig. 5 (on page 6) shows the specific cooling output for such arrangement.

If SKS-5/3 elements are installed as cooling islands, e.g. flush with a perforated or non-perforated suspended ceiling, the reflux of warmed room air into the ceiling plenum is hindered. This has an influence on the cooling output which is shown in the correction factor k_D in Fig. 6 (on page 6).

Reducing the clearance (h) between the concrete ceiling and the upper side of the SKS-5/3 element (when used as a cooling sail) also has an influence on the cooling output. In this case the drop in output ranges from 5% (if $h < 125$ mm) to a maximum of 14% (if the fastening profiles are fixed to the concrete ceiling, see Fig. 7). This also applies to large obstructing components such as air ducts, beams, etc.

The waterside pressure drop of the SKS-5/3 elements in relation to water flow rate and dimensions is shown in Fig. 8. For accurate pressure drop calculations, especially for elements connected in series, and for the calculation of optimized options or other system configurations, please contact our experts at our Aachen offices.

The SKS-5/3 system can also be used for heating purposes. This is particularly effective with elements arranged as sails and combined with a ceiling-mounted turbulent air distribution system. High heating outputs (referred to the active area) can be achieved since it is not necessary to limit the water supply temperature as is required in the cooling mode owing to the dew point of the room air. This is explained in detail in our technical report entitled "Heating and cooling with ceilings" (ref. 87/2002) which is available in our website www.krantz.de. Yet we would recommend that you consult our experts in Aachen in any case.

Static cooling ceiling system SKS-5/3

for visible installation

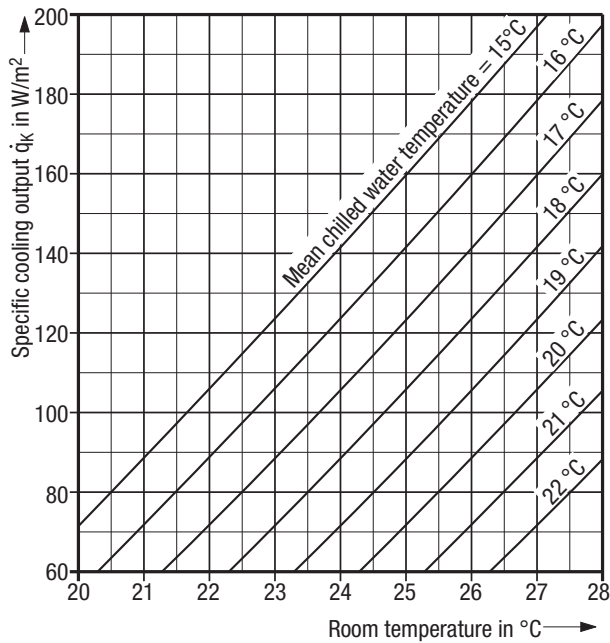

Fig. 5: Specific cooling output of SKS-5/3 elements (to DIN 4715-1)

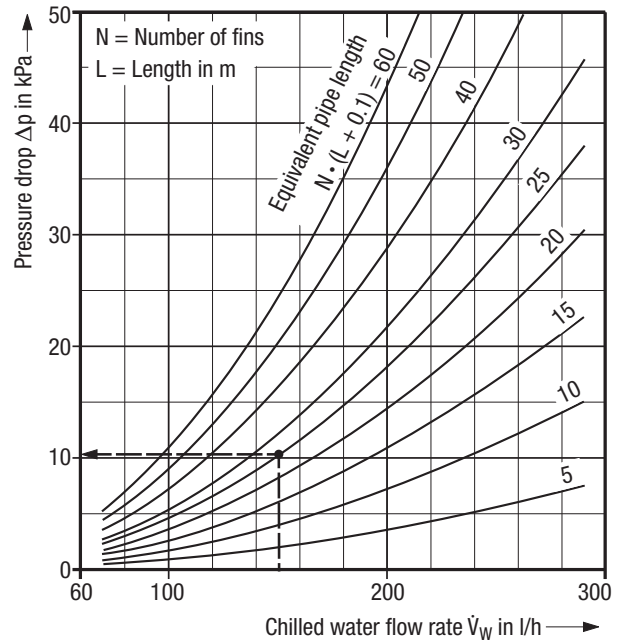

Fig. 8: Pressure drop calculation for SKS-5/3 elements

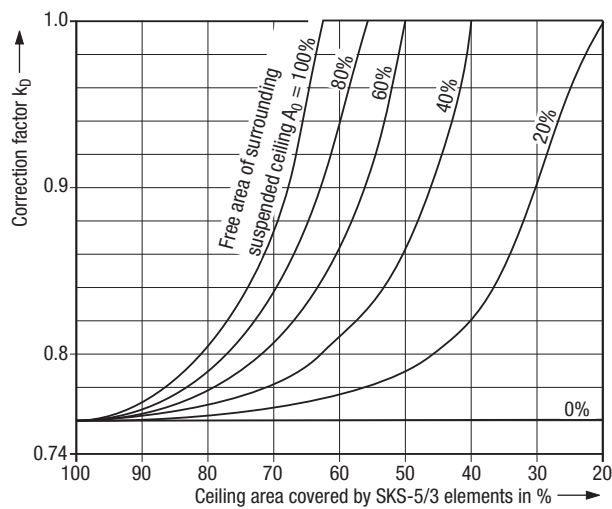

Fig. 6: Correction factor k_D for the influence of the free area (A_0) of the surrounding ceiling and the covered area on the cooling output (applies to metal ceilings with thickness 's' < 1 mm)

Clearance h in mm	Correction factor k_A
$h \geq 125$	1.00
$100 \leq h < 125$	0.95
$50 \leq h < 100$	0.86

Fig. 7: Correction factor k_A for the influence of the clearance between the concrete ceiling and the top side of the SKS-5/3 element (when used as a cooling sail)

Design specifications (cooling mode)

High-capacity cooling & heating ceiling systems have been in successful use for years in offices and assembly rooms as well as in spaces requiring increased cooling outputs (e.g. call centres, TV studios, manufacturing facilities, etc.). These ceiling systems make for great satisfaction of room occupants because they provide:

- constant temperatures over the entire room height,
 - low room air velocities in the occupied zone,
 - comfortable heat removal both by radiation and convection,
 - noiseless operation (principle of 'silent cooling'),
- and they can be combined with various air distribution systems.

The proven high-capacity static cooling ceiling system from KRANTZ KOMPONENTEN is particularly popular among building users owing to its reliable operation as well as the high cooling and heating outputs and the individual mounting options it provides.

To enable all trades involved in construction (architects, design consultants for facility and lighting systems respectively, etc.) to get optimum results, it is necessary to combine architecture and technical systems, i.e. in the present case to integrate visible ceiling elements into the interior design project. In the following section we are giving basic advice on system design and layout.

Static cooling ceiling system SKS-5/3

for visible installation

As already mentioned in the preliminary remarks, there are two basic arrangement options for SKS-5/3 elements:

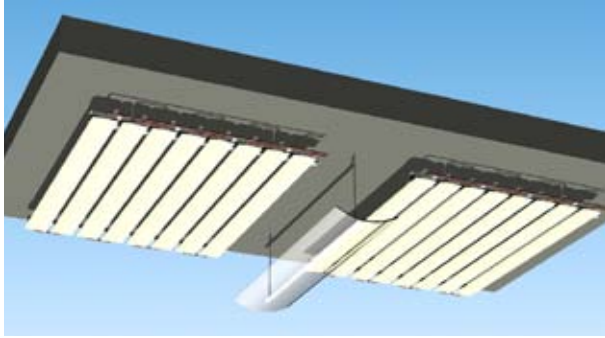

Fig. 9: Cooling/heating sail (freely suspended)

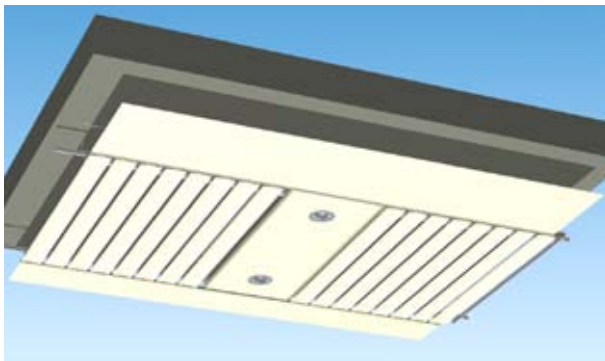

Fig. 10: Cooling/heating island (incorporated into a suspended ceiling)

The design and layout of the SKS-5/3 system is bound to a few factors which depend on both architectural and technical specifications.

We recommend to combine the visual arrangement options with the specific technical conditions at an early design stage. This refers in particular to:

- the maximum nominal dimensions of the cooling/heating elements,
- the orientation of the fins within the ceiling,
- the integration of ceiling services (lighting fixtures, air diffusers, sprinklers, etc.) into the cooling/heating sail.

The cooling & heating outputs required for layout result from the combination of the following parameters:

1. Temperatures

Room temperature

The room temperature is a variable which is determined and set on the basis of given specifications. The usual layout basis for office spaces in Germany is 26 °C. Yet this value may differ depending on the country where the SKS-5/3 system is to be installed.

Water temperatures

The water supply and return temperatures (the mean being called "mean water temperature") are important determinants for the output and the reliable operation of cooling & heating ceiling systems. They are influenced by:

1. the ambient air conditions (e.g. air humidity)
2. the mode of supply for fresh air
3. the energy-efficient system for providing the required water flow rate and temperature.

2. Mounting options

SKS-5/3 elements can be built into any type of suspended ceiling (either closed or open/perforated). The more closed the surrounding suspended ceiling, the more negative the impact on the cooling or heating output of the SKS-5/3 system. On the contrary, joints, for instance, will increase the system output.

SKS-5/3 elements can also be mounted as fully visible ceiling elements, without any suspended ceiling. This is made possible by the outstanding quality of SKS products. This application offers better cooling and heating dynamics under load changes and the storage capacity of the concrete slab becomes more significant.

3. Covered area

The covered area refers to the percentage of active cooling area in relation to the ceiling area.

Considering the very high output of the system, SKS-5/3 elements usually cover about 30–60% of the ceiling area under typical conditions. This leaves enough space for ceiling services such as lighting fixtures, fire detectors, etc.

Further information is contained in our publications:

- K 181/e "Cooling ceiling technology"
- DS 4076 e "Cooling ceiling system description".

Static cooling ceiling system SKS-5/3

for visible installation

The following graph is useful for predetermining approximately the percentage of SKS elements required in relation to the ceiling area. Fig. 11 shows the achievable specific cooling outputs per m² of ceiling area in relation to the area covered by SKS-5/3 elements designed as freely suspended cooling sail, at various design temperatures:

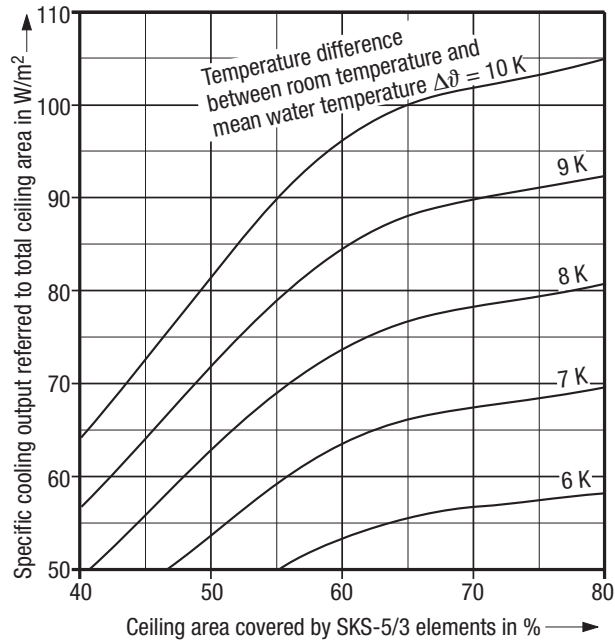

Fig. 11: Cooling outputs in relation to covered area and temperature difference

Further benefits of the high cooling and heating outputs of the SKS-5/3 system are provided by the possibility of altering somewhat the design parameters. This enables

- to use this system in rooms with very high heat loads,
- to significantly reduce the active cooling area as compared with closed cooling ceiling systems,
- to cut the water flow rate by increasing the difference between water supply and return temperatures,
- to operate the system with a water supply temperature ≥ 16 °C in order to reduce the risk of condensation at the coldest water pipes. This also significantly improves the conditions of use for the energy-efficient production of chilled water.

Layout fundamentals (cooling mode)

To determine the cooling output of the SKS-5/3 system you must use the following equation:

$$\dot{q} = \dot{q}_0 \cdot k_D \cdot k_A$$

where

\dot{q} = actual active specific cooling output in W/m²

\dot{q}_0 = specific cooling output as per Fig. 5

k_D = output correction factor as per Fig. 6

k_A = output correction factor as per Fig. 7

A_0 = free area within passive ceiling area, in %

A_{SKS} = L x B (max. 4 m²)

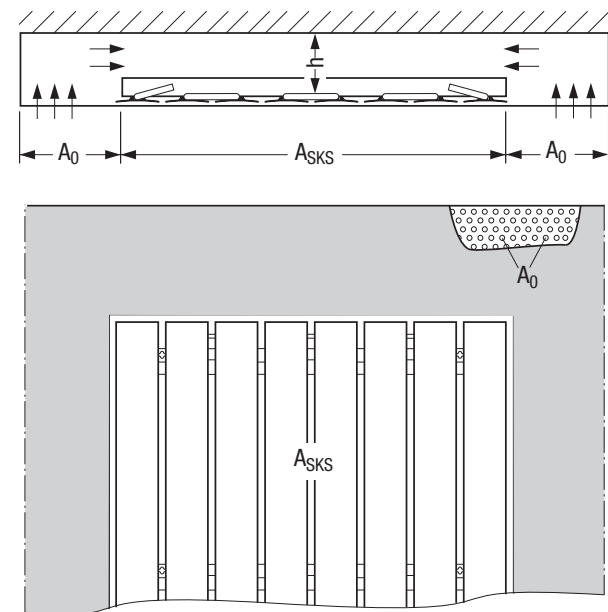

Fig. 12: Sketch showing A_0 and h

To determine the required water flow rate (\dot{V}_W), use the following equation:

$$\dot{V}_W = (0.86 \cdot \dot{q} \cdot A_{SKS}) / \Delta t_W$$

where

Δt_W = difference between water supply and return temperatures

Please note: $\dot{V}_W > 70$ l/h

After determining the water flow rate for each SKS-5/3 element, you can calculate the waterside pressure drop using the graph in Fig. 8.

Our 'Cooling & Heating Systems' experts have at their disposal appropriate tools to establish design parameters and calculate outputs and the influence of suspended ceilings and ceiling services. On enquiry they can carry out calculations for your specific projects.

Static cooling ceiling system SKS-5/3

for visible installation

Where the SKS-5/3 system is used, acoustic requirements at suspended ceiling level can be met as shown in Fig. 13. Any type of standard sound-absorbing material can be applied. On request test certificates on measurements carried out with adequate material can be made available.

If SKS-5/3 elements are designed as cooling islands, one should utilize the possibility of turning passive ceiling segments into active ones in order to further increase the acoustic performance in the room.

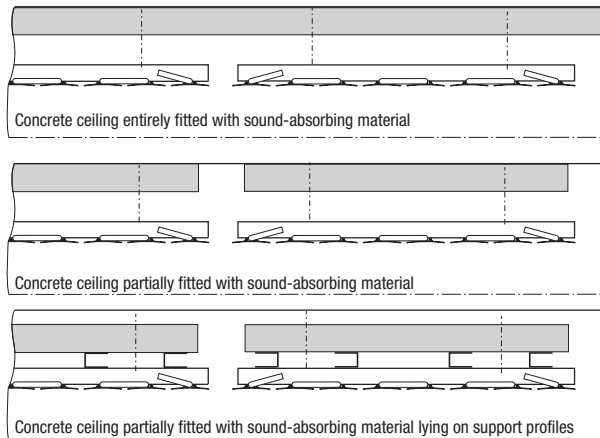

Fig. 13: Different options for combining sound-absorbing material with the SKS-5/3 system

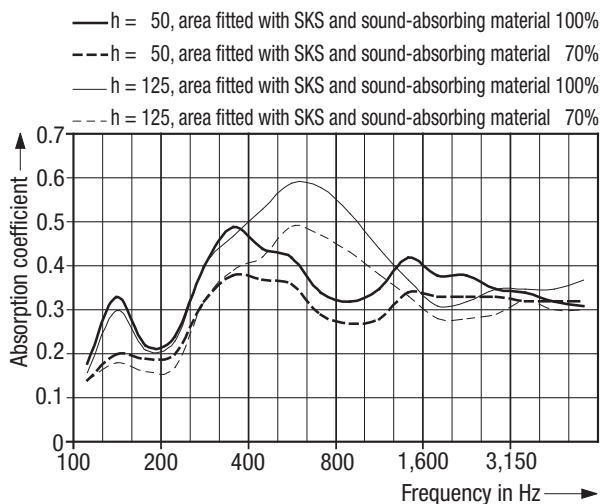

Fig. 14: Results of sound absorption measurements with the SKS-5/3 system

Mounting instructions

Owing to its inherent stability the SKS-5/3 system is easy to install. Yet as there are several arrangement and design options available, we recommend coordination with our experts at an early stage. We are therefore giving here only general mounting information.

SKS-5/3 elements are basically mounted in the horizontal plane. In exceptional cases provision may be made for an inclined position, but this will impair the output.

The SKS-5/3 elements are best suspended directly from the concrete ceiling using M8 threaded rods (2 pieces at each fastening profile as per items 4 + 5 in Fig. 1, at least 4 pieces per element) together with adequate anchors as authorized by the building authorities. It is advisable to fix the SKS-5/3 elements to rail systems in order to make up for usual constructional tolerances or to adjust the position of the elements to the facade, walls, and/or lighting fixtures, etc., as well as to one another. It is also possible to utilize standardized suspension systems like those used in drywall construction. In such case an expert drywall company should be involved in mounting.

Where required, sound insulation will be added to prevent noise from external sources, e.g. pump or valve noise, building noise and the like.

The water connections for the SKS-5/3 elements must be made in compliance with the general rules for water systems; they must be tensionless and they must not hinder the venting of the elements. We recommend using flexible connection hoses which can be provided by KRANTZ KOMPONENTEN upon request.

It is not allowed to suspend or fix other components or ceiling services to the fins or frames of the SKS-5/3 elements.

The design, delivery, and installation of the SKS-5/3 system call for appropriate care in order to preclude any risk of damage during transport, (intermediate) storage and mounting.

Static cooling ceiling system SKS-5/3

for visible installation

SKS-5/3 elements are delivered in adequate packages. For unloading and any on-site transport it is recommended to use industrial trucks. Upon request the packages can be prepared for unloading by crane. If intermediate storage is required, it should be in covered, dry and non-dusty storage spaces.

Operation and maintenance

SKS-5/3 elements are maintenance-free. During usual periodic inspections it is recommended to check the water pipes, fittings and connections, and still to have a look at the cooling/heating elements.

To prevent condensation, the operation of condensate probes and control systems along with their associated fittings will be checked following the manufacturers' specifications.

Tender text

..... units

Static cooling ceiling system SKS-5/3 consisting of single, compact, high-capacity cooling elements for easy ceiling mounting, with:

- copper serpentine piping \varnothing 12 x 0.5 mm featuring a smooth, neat and dry inside surface to DIN 1787 with tolerances to DIN 8905, with connections for chilled water inflow and outflow designed as inclined pipe ends,
- flat cooling fins with even underside, made from aluminium extruded profile, with chilled water pipes pressed onto,
- Z-shaped fastening profiles on the fins' upper sides to suspend the elements from the ceiling (number and type depending on element length and mounting conditions on site).

All visible parts are powder coated or wet painted.

Technical data

Cooling/Heating output of each element: W
Water supply temperature: °C
Water return temperature: °C
Room temperature: °C
Free area of surrounding passive ceiling (for arrangement as cooling island): %
Total covered area (exclusive of pipework): %
Water flow rate per element: l/h
Pressure drop per element: kPa
Max. operating pressure (standard):	600 kPa
Water quality:	Suitable mains water

Type code

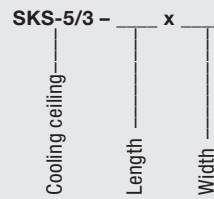

Length

.... = mm

Width

.... = mm

Dimensions:

Length: mm

Width: mm

Nominal height: 60 mm

Pipe spacing: 150 mm

Position of water connections (depending on number of fins):
one side or alternate sides

Connection type:

- Pipe end for push-in fitting, OD = 12 mm (standard)
- Pipe end for press fitting, OD = 12 mm

Colour:

- white similar to RAL 9010 (standard)
- other colour to RAL

Make: KRANTZ KOMponentEN

Type: SKS-5/3 - ____ x ____

Subject to technical alteration.

Krantz GmbH

Uersfeld 24, 52072 Aachen, Germany

Phone: +49 241 441-1

Fax: +49 241 441-555

info@krantz.de | www.krantz.de