



Rectangular displacement outlet Q-R....

Rectangular displacement outlet

Preliminary remarks

The rectangular displacement outlet is installed on the floor, either in front of a wall, parapet or pillar or free-standing in room, or built into room furniture. Several displacement outlets can be placed adjacent to each other. The following criteria must be taken into account for selection:

- Distance between outlet and workplace or seating (near-zone)
- Air outlet volume flow rate
- Discharge velocity
- Possible size
- Temperature difference between supply air and indoor air.

Our publication DS 4069 gives a general description of displacement ventilation with the calculation method for temperature gradients and cooling capacity. It also explains layout specifications for the near-zone depending on outlet placement.

The discharge velocity should always be kept below 0.25 m/s (see charts on pages 4 to 6). The requisite near-zone and the displacement outlet dimensions must be taken into consideration.

Construction design and function

The main components of the rectangular displacement outlet are the housing **1**, the perforated metal sheet **2** and the rectangular connection spigot **3**. Circular connection spigots are available for outlets with greater depth, see table on page 3.

On request, the back of the rectangular displacement outlet can be fitted with fasteners **4** for wall mounting.

The air is distributed through a built-in guide device that directs the discharged supply air jets at a slight upward incline and stabilizes them. This largely prevents a fast cold air drop and the associated rise in air velocity near the air outlet.

The perforated metal sheet generates a low-turbulence, low-momentum displacement flow to ensure the typical displacement ventilation jet pattern. The supply air spreads at about 10 to 30 cm above the floor at very low velocity.

The connection spigot can be positioned on the top or at the bottom of the outlet; lateral connection on request.

The external dimensions are presented in the table on page 3 for the standard sizes. Other dimensions on request.

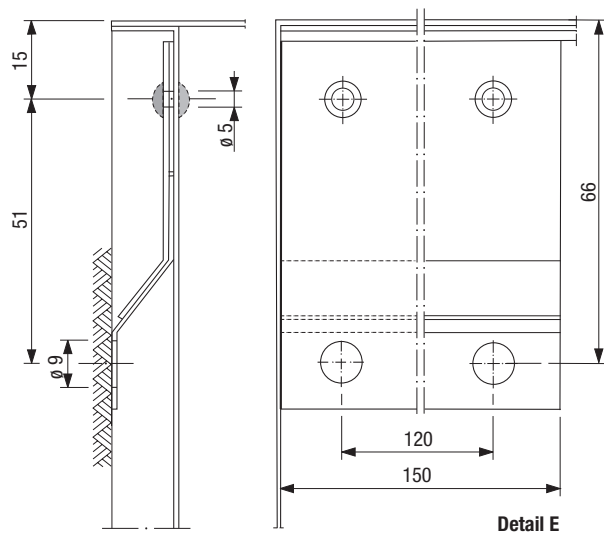
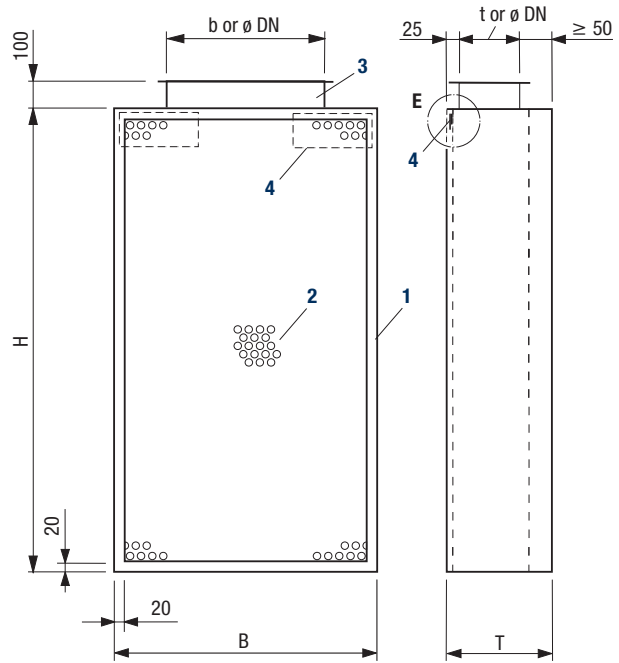

Rectangular displacement outlet

above: main dimensions

below: dimensions of fastener

Sound power level and pressure drop

Sound power level and pressure drop are largely determined by the volume flow rate and/or the air velocity in the connection spigot and the discharge velocity at the perforated front plate.

The free area of the perforated metal sheet is the same for all rectangular displacement outlets. The connection spigot for a certain size can vary to meet different acoustic requirements.

The charts on pages 4 to 6 show sound power level and pressure drop for various connection spigot dimensions and air volume flow rates. Other connection spigot dimensions on request.

Rectangular displacement outlet

Dimensions ¹⁾ and weights

Height H mm	Width B in mm																				
	500						880						1 380								
	Depth T	Spigot				Weight	Depth T	Spigot				Weight	Depth T	Spigot				Weight			
mm	b	t	ø DN ²⁾	A _{St} ³⁾	W approx. kg	mm	b	t	ø DN ²⁾	A _{St} ³⁾	W approx. kg	mm	b	t	ø DN ²⁾	A _{St} ³⁾	W approx. kg				
150	150	150	50		0.0075	3.5	150	300	50		0.015	6	150	300	50		0.015	8.5			
	150	200	50		0.0100		150	400	50		0.020		150	400	50		0.020				
	150	250	50		0.0125		150	500	50		0.025		150	500	50		0.025				
	200	150	100		0.0150	4	200	300	100		0.030	6.5	200	300	100		0.030	10			
300	150	200	50		0.010	5.5	150	300	50		0.015	9	150	400	50		0.020	13.5			
	150	300	50		0.015		150	400	50		0.020		150	600	50		0.030				
	150	400	50		0.020		150	500	50		0.025		200	400	100		0.040				
	200	250	100		0.025	6	200	300	100		0.030	10	200	500	100		0.050	15			
500	200	150	100		0.015	9	200	250	100		0.025	14.5	200	250	100		0.025	21.5			
	200	200	100		0.020		200	300	100		0.030		200	500	100		0.050				
	200	250	100		0.025		200	400	100		0.040		200	750	100		0.075				
	200	300	100		0.030		200	500	100		0.050		200	1 000	100		0.100				
	300			180	0.025	10.5	300			180	0.025	16	300			200	0.031	24			
	300			200	0.031		300			200	0.031		300			2x200	0.062	24.5			
880	200	200	100		0.020	14.5	200	400	100		0.040	23	200	500	100		0.050	34			
	200	300	100		0.030		200	500	100		0.050		200	750	100		0.075				
	200	400	100		0.040		300	300	200		0.060		25.5	300	500	200			0.100		
	300	250	200		0.050	16.5	300	350	200		0.070	26.5	300	625	200		0.125	37.5			
	300	300	200		0.060		300	400	200		0.080		300	750	200		0.150				
	300			200	0.031		300	500	200		0.100		300	1 000	200		0.200				
	350			250	0.049		17.5	350			250		0.049	26.5	350				250	0.049	38.5
	400			315	0.078		18.5	400			315		0.078	28	400				315	0.078	40.5
1 380	200	400	100		0.040	21	200	500	100		0.050	34	200	1 000	100		0.100	50.5			
	300	300	200		0.060	24	200	750	100		0.075		37.5	300	750	200			0.150		
	300	400	200		0.080		300	500	200		0.100	300		1 000	200		0.200				
	400	400	250		0.100		27.5	300	625	200		0.125		40.5	400	825	300		0.248		
	400	400	300		0.120	300		750	200		0.150	400	1 000		300		0.300				
	400			225	0.040	27		400			225	0.040	40.5		400			225	0.040		
	400			250	0.049			400			250	0.049			400			250	0.049		
	400			315	0.078		400			315	0.078	400				315	0.078				

¹⁾ Other dimensions on request

³⁾ A_{St} = cross-section of connection spigot

²⁾ The external diameter of the connection spigot is 1 mm smaller than ø DN

Rectangular displacement outlet ¹⁾

Sound power level and pressure drop

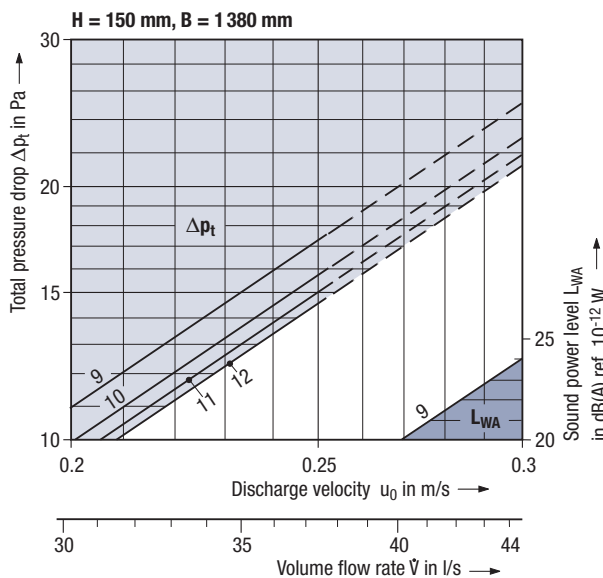
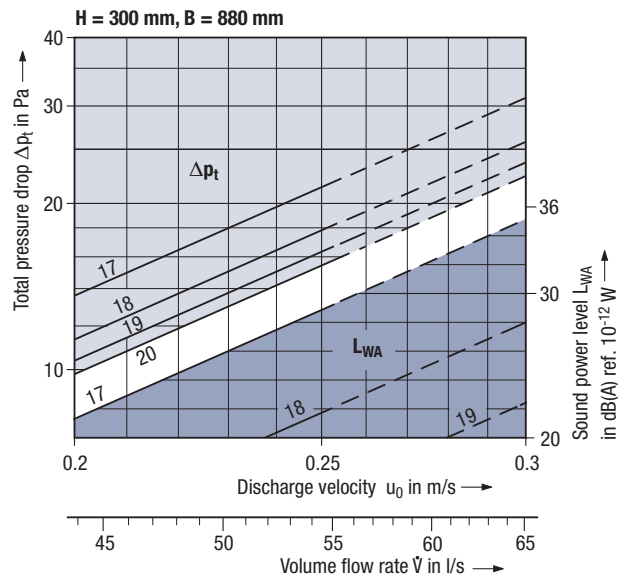
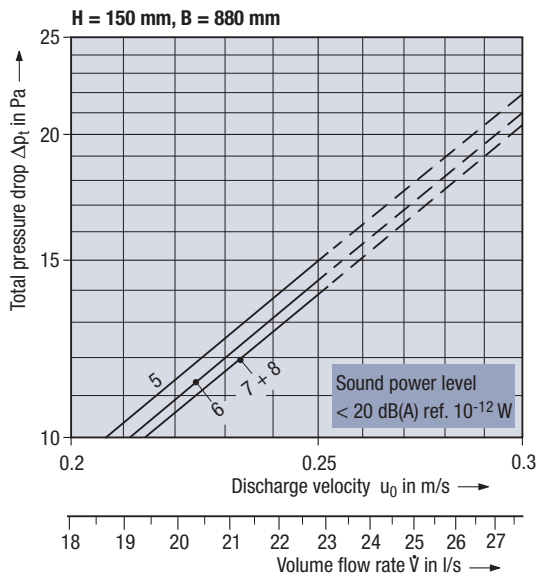
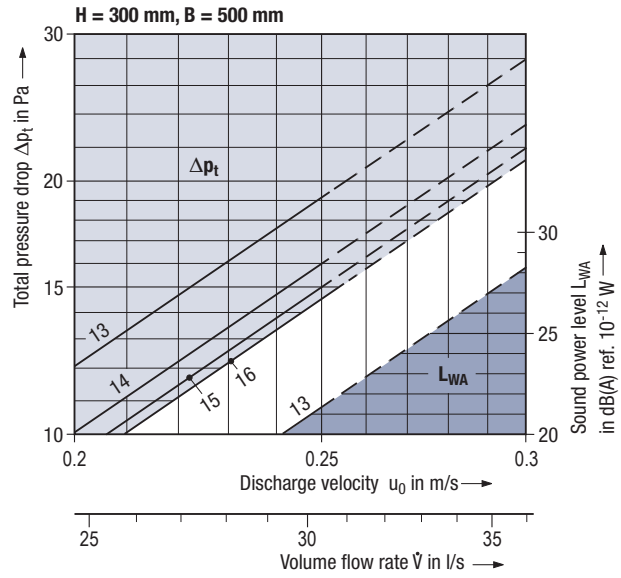
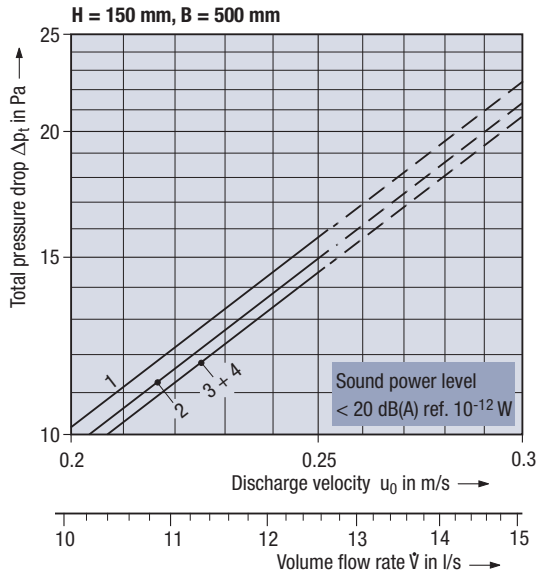

No.	T mm	b mm	t mm
1 *	150	150	50
2 *	150	200	50
3 *	150	250	50
4 *	200	150	100
5 *	150	300	50
6 *	150	400	50
7 *	150	500	50
8 *	200	300	100
9	150	300	50
10 *	150	400	50
11 *	150	500	50
12 *	200	300	100
13	150	200	50
14 *	150	300	50
15 *	150	400	50
16 *	200	250	100

No.	T mm	b mm	t mm
17	150	300	50
18	150	400	50
19	150	500	50
20 *	200	300	100

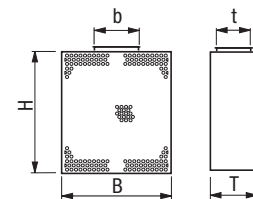

* Sound power level ≤ 20 dB(A) ref. 10^{-12} W

¹⁾ The discharge velocity [related to $(B - 40) \times (H - 40)$ in the charts] must always be < 0.25 m/s

Rectangular displacement outlet 1)

Sound power level and pressure drop

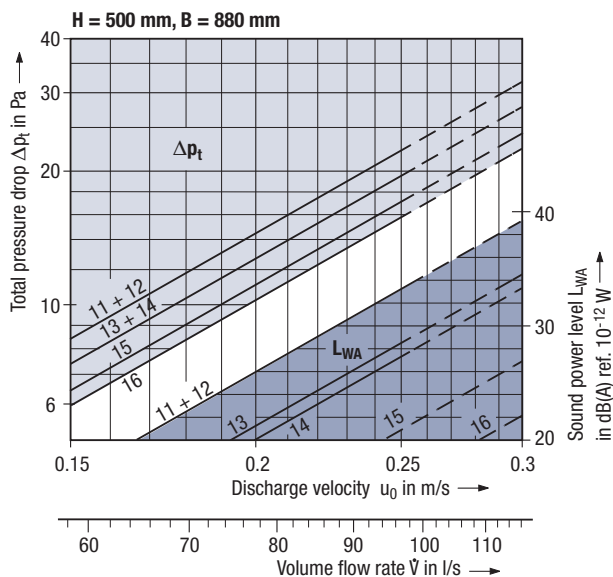
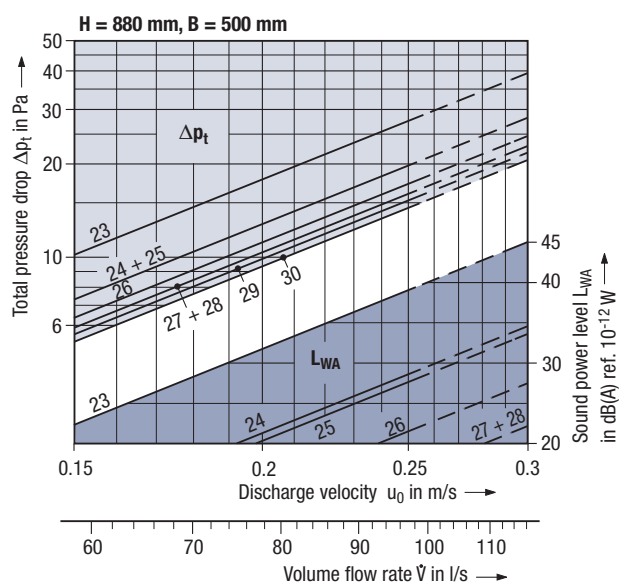
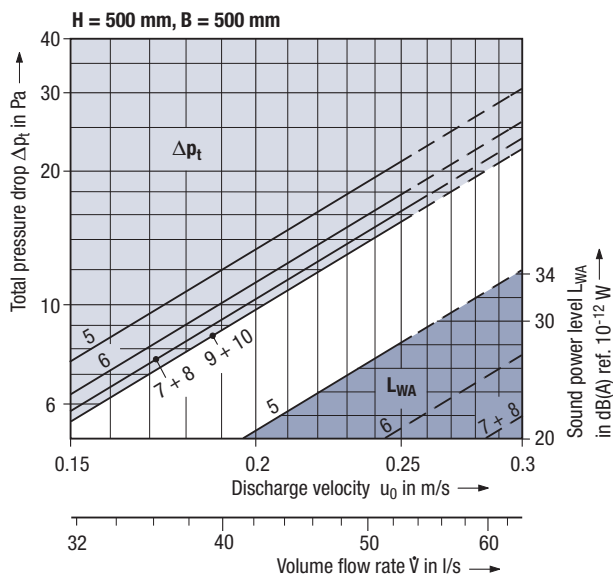
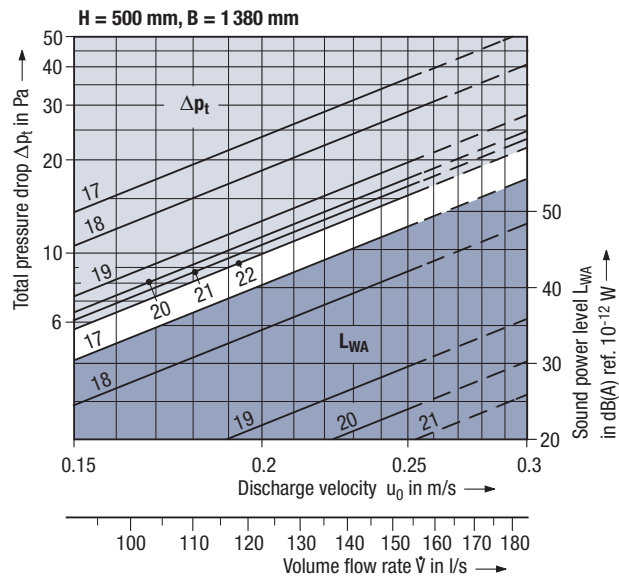
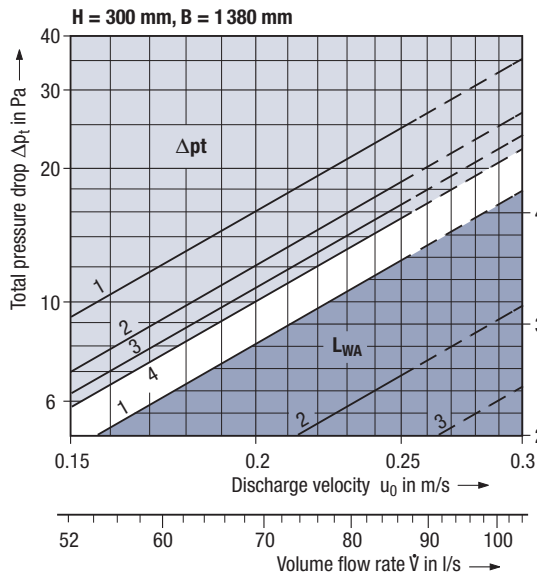

No.	T mm	b mm	t mm	ϕ DN mm
1	150	400	50	—
2	150	600	50	—
3	200	400	100	—
4*	200	500	100	—
5	200	150	100	—
6	200	200	100	—
7	200	250	100	—
8	300	—	—	180
9*	200	300	100	—
10*	300	—	—	200
11	200	250	100	—
12	300	—	—	180
13	200	300	100	—
14	300	—	—	200
15	200	400	100	—
16	200	500	100	—
17	200	250	100	—
18	300	—	—	200
19	200	500	100	—
20	300	—	—	2x 200
21	200	750	100	—
22*	200	1000	100	—

No.	T mm	b mm	t mm	ϕ DN mm
23	200	200	100	—
24	200	300	100	—
25	300	—	—	200
26	200	400	100	—
27	350	—	—	250
28	300	250	200	—
29*	300	300	200	—
30*	400	—	—	315

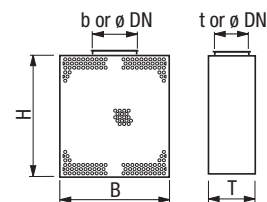

* Sound power level ≤ 20 dB(A) ref. 10^{-12} W

1) The discharge velocity [related to $(B - 40) \times (H - 40)$ in the charts] must always be < 0.25 m/s

Rectangular displacement outlet 1)

Sound power level and pressure drop

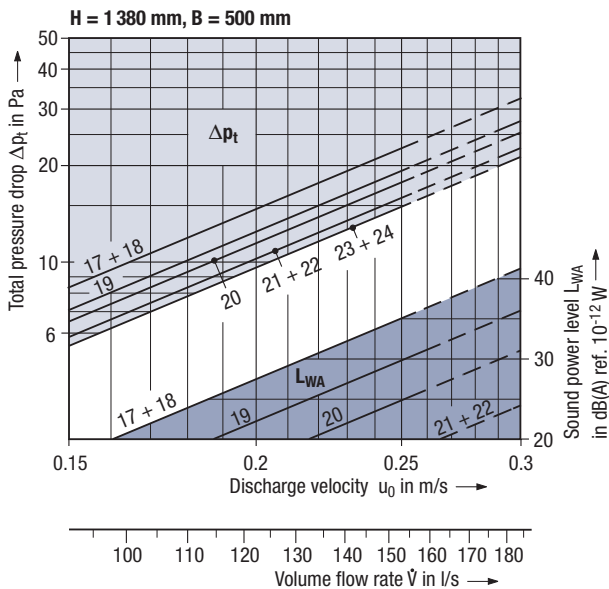
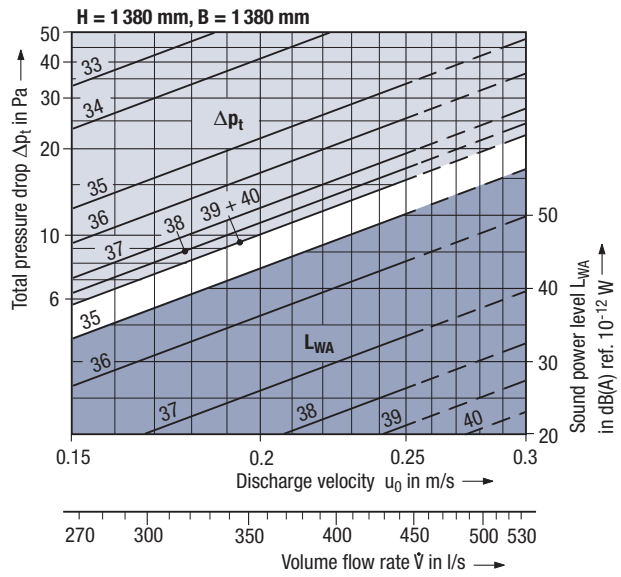
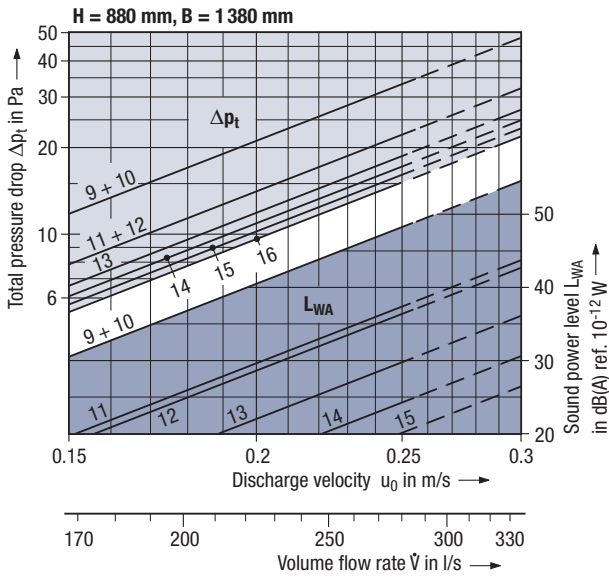
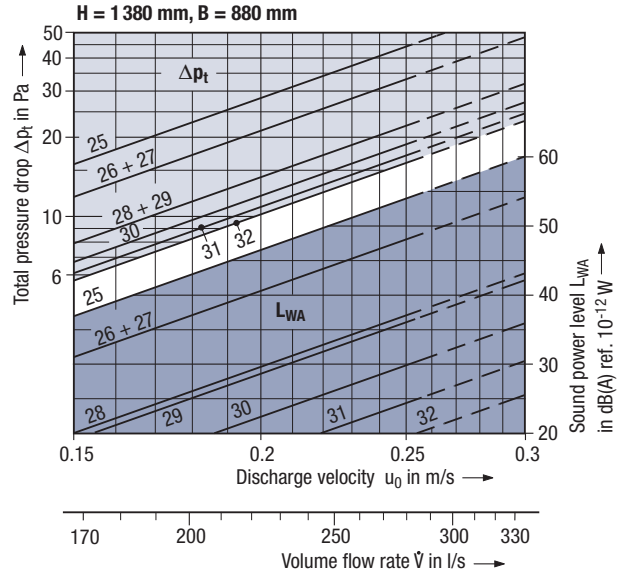
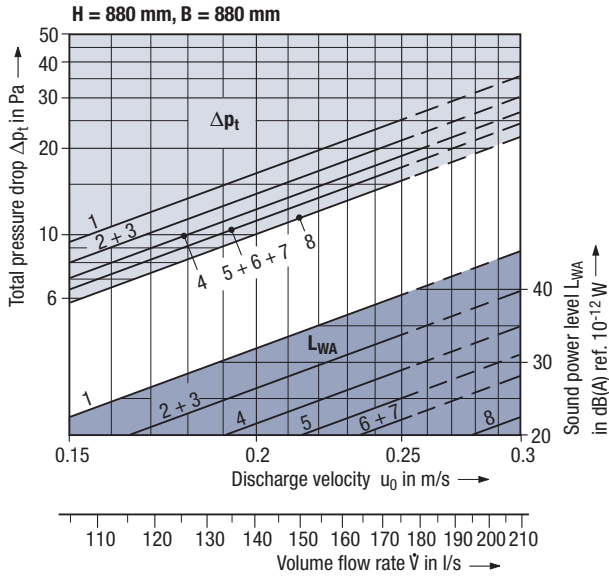

No.	T mm	b mm	t mm	ø DN mm
1	200	400	100	—
2	350	—	—	250
3	200	500	100	—
4	300	300	200	—
5	300	350	200	—
6	400	—	—	315
7	300	400	200	—
8	300	500	200	—
9	350	—	—	250
10	200	500	100	—
11	200	750	100	—
12	400	—	—	315
13	300	500	200	—
14	300	625	200	—
15	300	750	200	—
16*	300	1000	200	—
17	400	—	—	225
18	200	400	100	—
19	400	—	—	250
20	300	300	200	—
21	400	—	—	315
22	300	400	200	—
23*	400	400	250	—
24*	400	400	300	—

No.	T mm	b mm	t mm	ø DN mm
25	400	—	—	225
26	400	—	—	250
27	200	500	100	—
28	200	750	100	—
29	400	—	—	315
30	300	500	200	—
31	300	625	200	—
32	300	750	200	—
33*	400	—	—	225
34*	400	—	—	250
35	400	—	—	315
36	200	1000	100	—
37	300	750	200	—
38	300	1000	200	—
39	400	825	300	—
40	400	1000	300	—

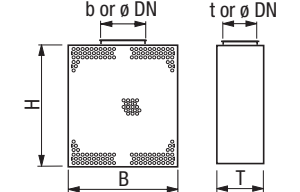

* Sound power level ≤ 20 dB(A) ref. 10^{-12} W

1) The discharge velocity [related to $(B - 40) \times (H - 40)$ in the charts] must always be < 0.25 m/s

Rectangular displacement outlet

Features

- Even, low-turbulence and draught-free discharge flow with small near-zone around the outlet
- Large coverage (5 to 15 m)
- Low sound power level
- Temperature difference between supply and indoor air usually -2 to -3 K and between supply and return air up to about -12 K, depending on room height and volume flow rate
- Single installation or in close sequence
- Connection spigot available in various sizes depending on acoustic requirements; position on top or at bottom
- Visually attractive design
- Air outlet made of galvanized sheet metal, face powder coated to RAL
- Available in many sizes
- Maintenance-free

Tender text

..... units

Rectangular displacement outlet to generate extremely low-turbulence displacement flow with large penetration depth in commercial rooms, air distribution via integrated guide device, placement on the floor, either in front of a wall, parapet or pillar or free-standing in room, or integration into room furniture,

consisting of:

- slim rectangular housing with perforated metal front sheet,
- either with rectangular connection spigot (to fit standard ducts) with optional corner flange or with circular connection spigot to fit ducts to EN 1506 (spiral seam ducts) or to EN 13180 (flexible ducts);
- position of connection spigot on top or at bottom,
- optional fasteners for wall mounting.

Type code

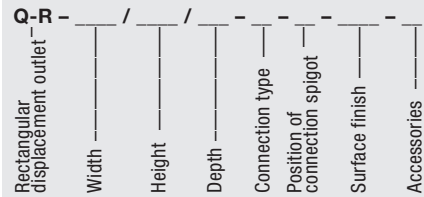

Width

500 = width 500 mm 1000 = width 1 000 mm
 880 = width 880 mm 1380 = width 1 380 mm

Height

150 = height 150 mm 880 = height 880 mm
 300 = height 300 mm 1000 = height 1 000 mm
 500 = height 500 mm 1380 = height 1 380 mm

Depth

150 = depth 150 mm 300 = depth 300 mm
 200 = depth 200 mm

Connection type

S = rectangular spigot, smooth
 Z = rectangular spigot with corner flange

Position of connection spigot

O = connection spigot on top
 U = connection spigot at bottom

Surface finish

9010 = face painted to RAL 9010, semi-matt
 = face painted to RAL

Accessories

O = none
 Z = fasteners for wall mounting

Material:

Air outlet made of galvanized sheet metal, face powder coated to RAL

Make:

KRANTZ KOMponenten

Type:

Q-R-___/___/___-___-___-___-__

Subject to technical alterations.

Krantz GmbH

Uersfeld 24, 52072 Aachen, Germany

Phone: +49 241 441-1

Fax: +49 241 441-555

info@krantz.de | www.krantz.de

The logo for Krantz GmbH, featuring the word "Krantz" in a stylized, blue, cursive script font.