



Krantz Components

Crosstalk attenuation air transfer element
OG, with built-in crosstalk silencer

Air distribution systems

Krantz

Crosstalk attenuation air transfer element

Preliminary remark and construction design

Preliminary remark

The crosstalk attenuation air transfer element with built-in crosstalk silencer by Krantz is characterized by a high level of sound absorption at low pressure drop, an attractive design, and ease of installation.

It is designed for mounting in plasterboard walls to enable return air transfer to adjacent inner zones such as corridors, false ceilings or adjacent rooms. The collected return or rather transferred air is removed from the building by a central air-conditioning plant; this obviates the need for return air ducts.

The crosstalk attenuation air transfer element is particularly suited for administrative and office buildings. The built-in crosstalk silencer reduces sound transmission from one room to the adjacent one, thus ensuring the privacy of conversations.

Construction design

The standard crosstalk attenuation air transfer element is available in S-shape for a wall thickness of 100 mm and in T-shape for a wall thickness of 125 mm¹⁾. Both designs are available in two nominal lengths. Further, it is possible to cover the wall opening with a decorative front plate which is powder coated to RAL 9010 and has either round perforations \varnothing 5 mm or rectangular slots 51 x 5 mm²⁾. Thanks to two clip connections the front plate can be easily and quickly mounted upon completion of the room; it is thus protected from dirt and damage during the room construction.



Fig. 1: Crosstalk attenuation air transfer element in S-shape and T-shape

¹⁾ Special designs for other wall thicknesses on request

²⁾ Other colours and designs for front plate on request



2a

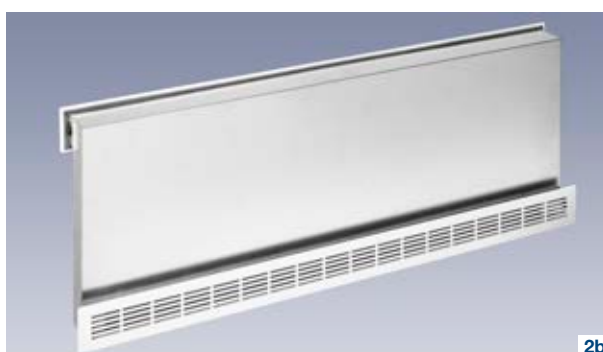

2b

Fig. 2: Crosstalk attenuation air transfer element in S-shape

2a: Front plate with round perforations Rv 5/7

2b: Front plate with rectangular slots 51-5



3a



3b

Fig. 3: Crosstalk attenuation air transfer element in T-shape

3a: Front plate with round perforations Rv 5/7

3b: Front plate with rectangular slots 51-5

Crosstalk attenuation air transfer element

Dimensions

S-shape with front plate

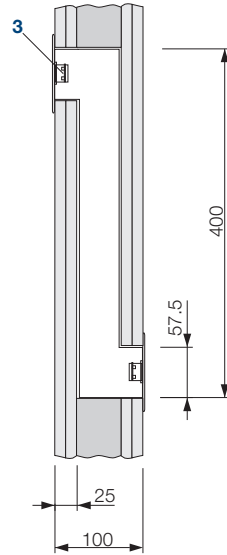
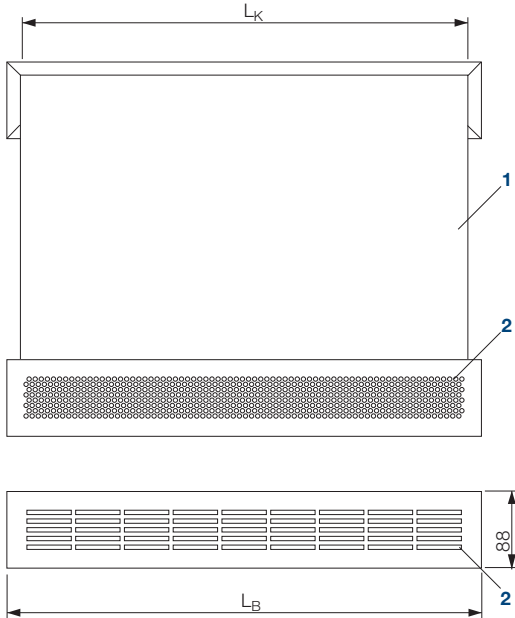

S-shape without front plate

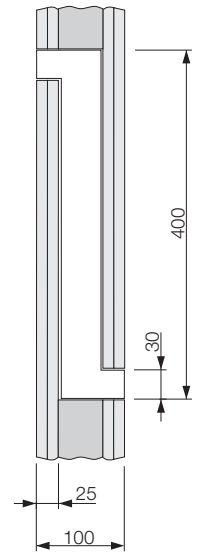

T-shape with front plate

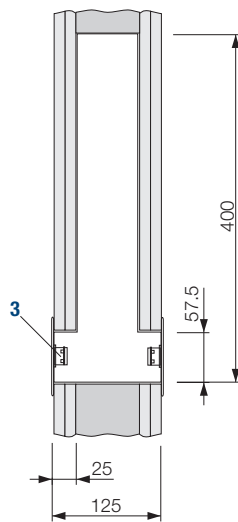
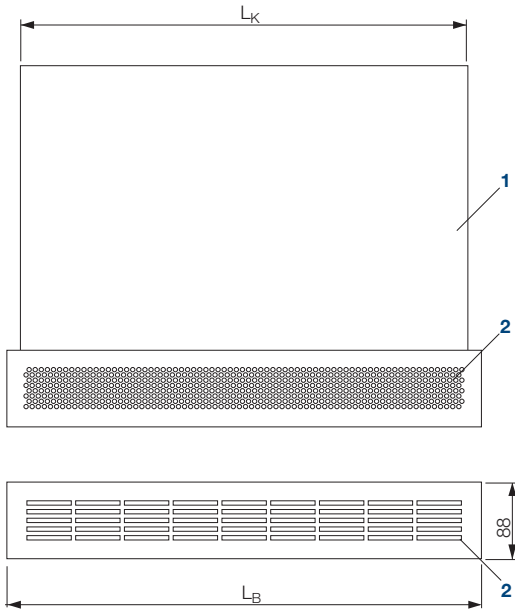

T-shape without front plate

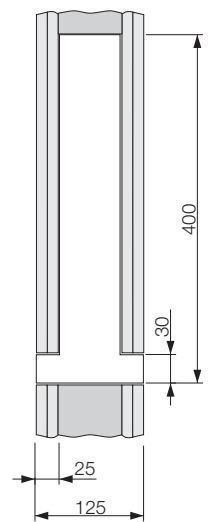

Wall opening

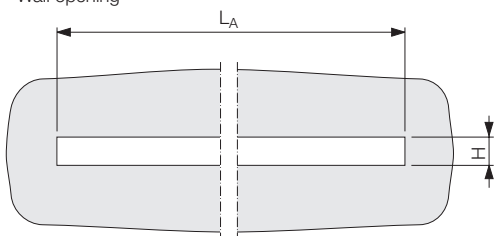

Key

- 1 Housing with built-in crosstalk silencer
- 2 Front plate either with round perforations Rv 5/7 or with rectangular slots 51-5
- 3 Clip connection

Nominal length	Front plate	L _K mm	L _B mm	L _A ¹⁾ mm	H ¹⁾ mm
500	with	515	545	525	62
	without				36
1 000	with	1 020	1 050	1 030	62
	without				36

¹⁾ Wall opening

Crosstalk attenuation air transfer element

Technical data

For the selection of a crosstalk attenuation air transfer element, the pressure drop and the structural parameters for the reduction of airborne sound are required.

Pressure drop

The allowable pressure drop must be agreed upon with the client. Maximum pressure drop values of 10 – 15 Pa are usual.

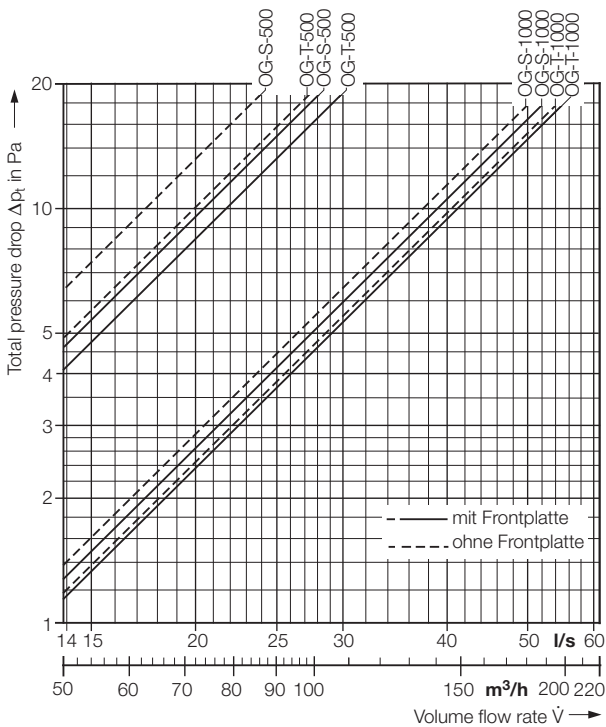

The crosstalk attenuation air transfer element from Krantz achieves the acoustic data mentioned in Table 1.

Table 1: Design with and without front plate

	Front plate	R_W/dB ¹⁾	R_W/dB ²⁾	$D_{n,e,w}/dB$
OG-S-500	with	16	24	41
	without	16	27	44
OG-S-1000	with	16	24	38
	without	16	27	41
OG-T-500	with	19	27	44
	without	19	30	47
OG-T-1000	with	18	27	41
	without	18	29	43

Key:

- A = equivalent sound absorption area in the receiving room in m^2
- A_0 = reference sound absorption area, $10 m^2$
- $D_{n,e}$ = element-normalized level difference in dB
- $D_{n,e,w}$ = weighted element-normalized level difference in dB (measurements to EN ISO 10140)
- L_1 = sound pressure level in the source room in dB
- L_2 = sound pressure level in the receiving room in dB
- R = sound reduction index of the air transfer element in dB
- R_W = weighted sound reduction index in dB
- $R_{W, res}$ = resulting sound reduction index in dB
- S = area of the free opening in which the air transfer element is installed, in m^2

Acoustic data

In order to reduce sound transmission from one room to the adjacent one (e.g. from office to corridor) to an acceptable level, the crosstalk attenuation air transfer element from Krantz is lined with abrasion-resistant sound-absorbing material. The resulting acoustic data regarding airborne sound reduction are given via the sound reduction index and the normalised sound level difference.

The sound reduction index R is defined as follows:

$$R = L_1 - L_2 + 10 \cdot \log(S/A)$$

The element-normalized level difference is given by the following equation:

$$D_{n,e} = L_1 - L_2 + 10 \cdot \log(A_0/A)$$

¹⁾ weighted sound reduction index (R_W) referred to wall opening

²⁾ weighted sound reduction index (R_W) referred to width x height of crosstalk attenuation air transfer element

Crosstalk attenuation air transfer element

Layout example

The following example shows how to calculate the resulting sound reduction index $R_{w, res}$ of a room wall. Both the dimensions and the sound reduction indexes of the individual building elements are required for this purpose. In this example we have considered usual values for the wall (plasterboard wall, 125 mm thick) and the door.

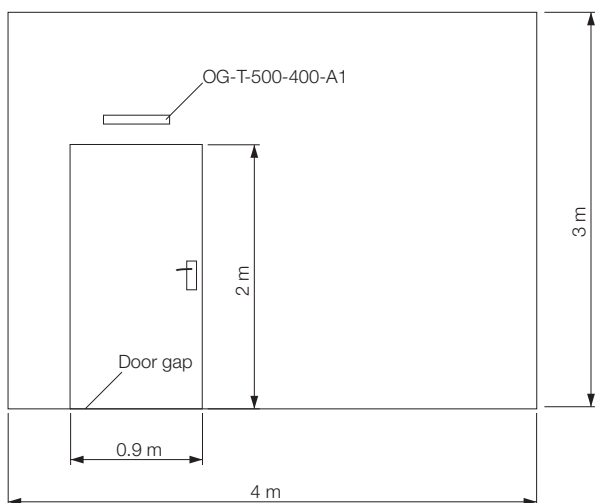

The calculation is performed according to the following equation:

$$R_{w, res} = -10 \log \left[\frac{1}{S_{total}} \cdot \sum_{i=1}^n S_i \cdot 10^{(-R_{W, i}/10)} \right]$$

Considering the following data:

Room width:	4 m
Room height:	3 m
Door area:	1.8 m ²
Total area S_{total} :	12 m ²
OG-T-500 with a front plate on each side	
Area of crosstalk attenuation air transfer element referred to:	
– width x height:	0.21 m ²
– wall opening:	0.03 m ²
Sound reduction indexes R_W to DIN 4109:	
wall:	53 dB
door:	37 dB

The equation for $i = 3$ ($\hat{=}$ 3 building elements: wall, door, and crosstalk attenuation air transfer element or door gap) is:

$$R_{w, res} = -10 \log \left[\frac{1}{S_{total}} \cdot (S_1 \cdot 10^{(-R_{W, 1}/10)} + S_2 \cdot 10^{(-R_{W, 2}/10)} + S_3 \cdot 10^{(-R_{W, 3}/10)}) \right]$$

The following tables show the calculation results.

The resulting sound reduction index $R_{w, res}$ is identical for both reference areas of the crosstalk attenuation air transfer element. The calculation shall take into consideration that the sound reduction index depends on the corresponding reference area.

Calculation table: referred to wall opening

	Reference area S_i m ²	Weighted sound reduction index $R_{W, i}$ dB	Resulting sound reduction index $R_{w, res}$ dB
Wall	10.17	53	42
Door	1.8	37	
OG-T-500	0.03	19	

Calculation table: referred to width x height of crosstalk attenuation air transfer element

	Reference area S_i m ²	Weighted sound reduction index $R_{W, i}$ dB	Resulting sound reduction index $R_{w, res}$ dB
Wall	9.99	53	42
Door	1.8	37	
OG-T-500	0.21	27	

Calculation of resulting sound reduction index for combination of door gap and wall

The following table shows the resulting sound reduction index in case the air flows into the adjacent room through the door gap instead of through the crosstalk attenuation air transfer element. A door gap of 10 mm height has been considered.

The resulting sound reduction index $R_{w, res}$ is no more than 31 dB.

Calculation table: referred to door gap

	Reference area S_i m ²	Weighted sound reduction index $R_{W, i}$ dB	Resulting sound reduction index $R_{w, res}$ dB
Wall	10.191	53	31
Door	1.8	37	
Door gap	0.009	0	

Conclusion:

To keep sound transmission from one room to the adjacent one (e.g. from office to corridor) to an acceptable level, the air should be transferred via specially designed crosstalk attenuation air transfer elements.

Air transfer through a door gap results in an unacceptably high reduction of the sound reduction index of the room wall.

Crosstalk attenuation air transfer element

Features, type code and tender text

Features

- Designed for flush mounting in plasterboard walls, wall thickness 100 and 125 mm ¹⁾
- With built-in crosstalk silencer for reduction of sound transmission from one room to the adjacent one
- High level of sound absorption at low pressure drop
- Attractive design – On request the wall opening can be covered with a decorative front plate
- Volume flow rate up to max. 53 l/(s·m) [190 m³/(h·m)] referred to a pressure drop Δp_t of 15 Pa (with T-shape $\dot{V}_{max} \approx 47$ l/(s·m) [170 m³/(h·m)])
- Easy to install

Tender text

..... units

Crosstalk attenuation air transfer element with built-in crosstalk silencer for mounting in plasterboard walls, for reduction of sound transmission from one room to the adjacent one,

element consisting of:

- housing available either with staggered openings (S-shape) or with opposite openings on one level (T-shape), with built-in crosstalk silencer
- optional front plate on each side, fitted with round perforations or rectangular slots; easy fastening with clip connections

Type code

OG - - - 400 - - -

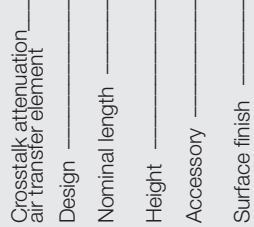

Design

- S = S-shape, wall thickness 100 mm
- T = T-shape, wall thickness 125 mm

Nominal length ²⁾

- 500 = Nominal length 500
- 1000 = Nominal length 1 000

Height

- 400 = Height 400 mm

Accessory ³⁾

- O = without front plate
- A1 = front plate with round perforations Rv 5/7
- A2 = front plate with rectangular slots 51·5

Surface finish ⁴⁾

- 9010 = face painted to RAL 9010, semi-matt

Material:

- Housing made of galvanized sheet metal
- Crosstalk silencer made of abrasion-resistant acoustic lining (Basotect) of fire resistance class B1 to DIN 4102-1
- Front plate made of galvanized sheet metal powder coated to RAL 9010, pure white

Make:

Krantz

Type:

OG - - - 400 - - -

Subject to technical alterations.

¹⁾ Special designs for other wall thicknesses on request

²⁾ Other nominal lengths on request

³⁾ Other front plate designs on request

⁴⁾ Other colours on request

Krantz GmbH

Uersfeld 24, 52072 Aachen, Germany

Phone: +49 241 441-1

Fax: +49 241 441-555

info@krantz.de | www.krantz.de

The logo for Krantz GmbH, featuring the word "Krantz" in a stylized, blue, cursive script font.